

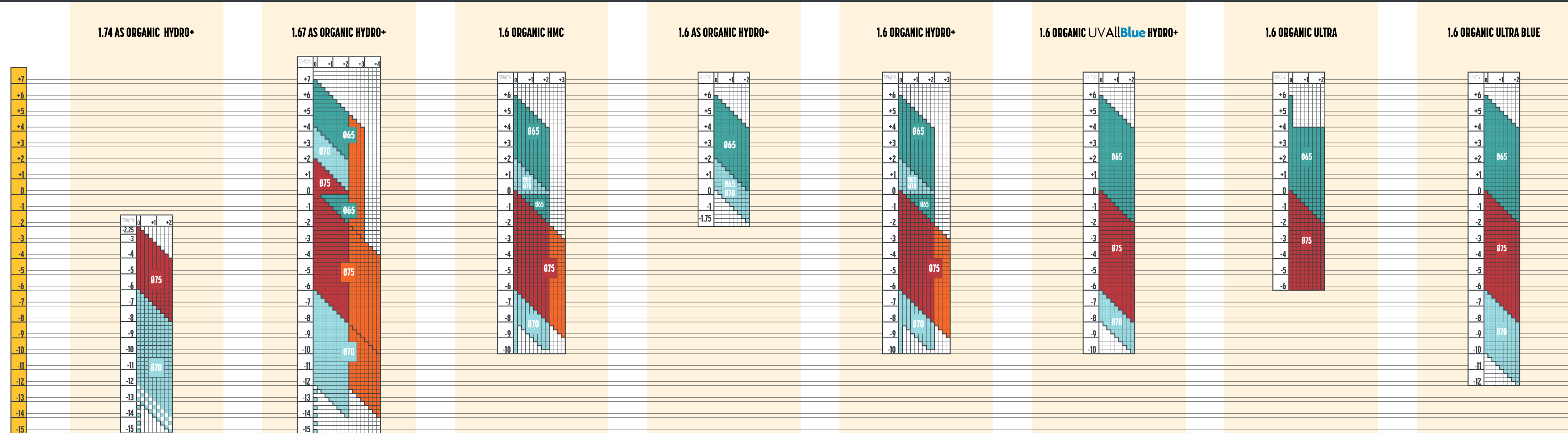

CATALOG DOMENII LENTILE

LENTILE DE STOC



Cilindru înalt

Cilindru înalt



Cilindru înalt

Colorare	NU	NU	NU	NU	NU	NU	NU	NU
Tratamente disponibile	HYDRO+	HYDRO+	HMC	HYDRO+	HYDRO+	HYDRO+	ULTRA	ULTRA BLUE
Tratamente adiționale	-	-	-	-	-	-	-	-

ORGANIC STOC
LENTILE TRANSPARENTE
INDICE: 1.74 / 1.67 / 1.6

ORGANIC STOC - LENTILE TRANSPARENTE - INDICE: 1.59 / 1.56 / 1.53

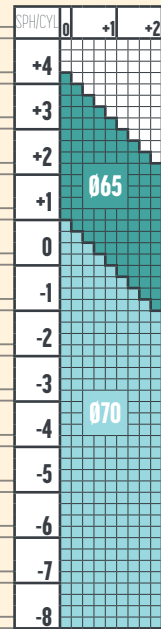
1.59 POLY HMC



1.56 AS ORGANIC HMC



1.56 ORGANIC HMC

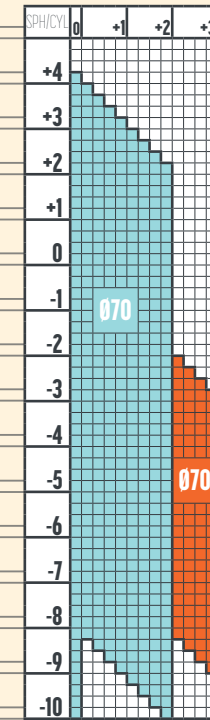

1.53 TRIVEX HMC

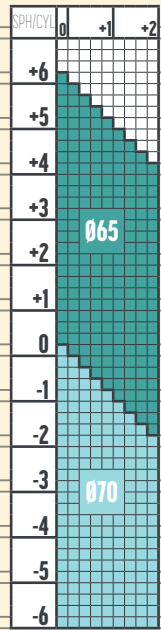

Cilindru înalt



Colorare	NU	NU	NU	NU
Tratamente disponibile	HMC	HMC	HMC	HMC
Tratamente adiționale	-	-	-	-

ORGANIC STOC
LENTILE TRANSPARENTE
INDICE: 1.59 / 1.56 / 1.53

ORGANIC STOC - LENTILE TRANSPARENTE - INDICE 1.5

1.5 ORGANIC ULTRA BLUE

1.5 ORGANIC ULTRA

1.5 ORGANIC PURE

1.5 ORGANIC HYDRO+

1.5 ORGANIC UVA(Blue) HYDRO+

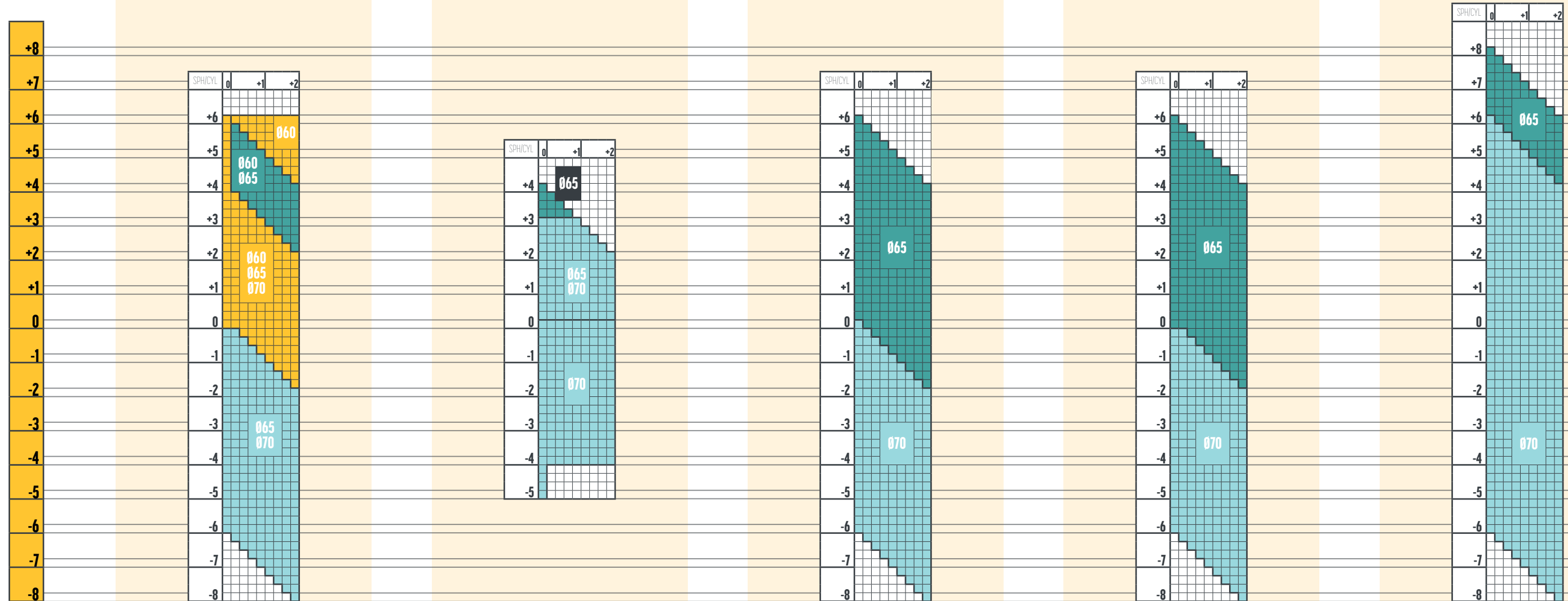

Colorare	NU	NU	NU	NU	NU
Tratamente disponibile	ULTRA BLUE	ULTRA	PURE	HYDRO+	HYDRO+
Tratamente adiționale	-	-	-	-	-

ORGANIC STOC
LENTILE TRANSPARENTE
INDICE: 1.5

ORGANIC STOC - LENTILE TRANSPARENTE - INDICE 1.5

1.5 ORGANIC HMC

1.5 ORGANIC HC

1.5 ORGANIC UC

1.5 ORGANIC KIDS HMC

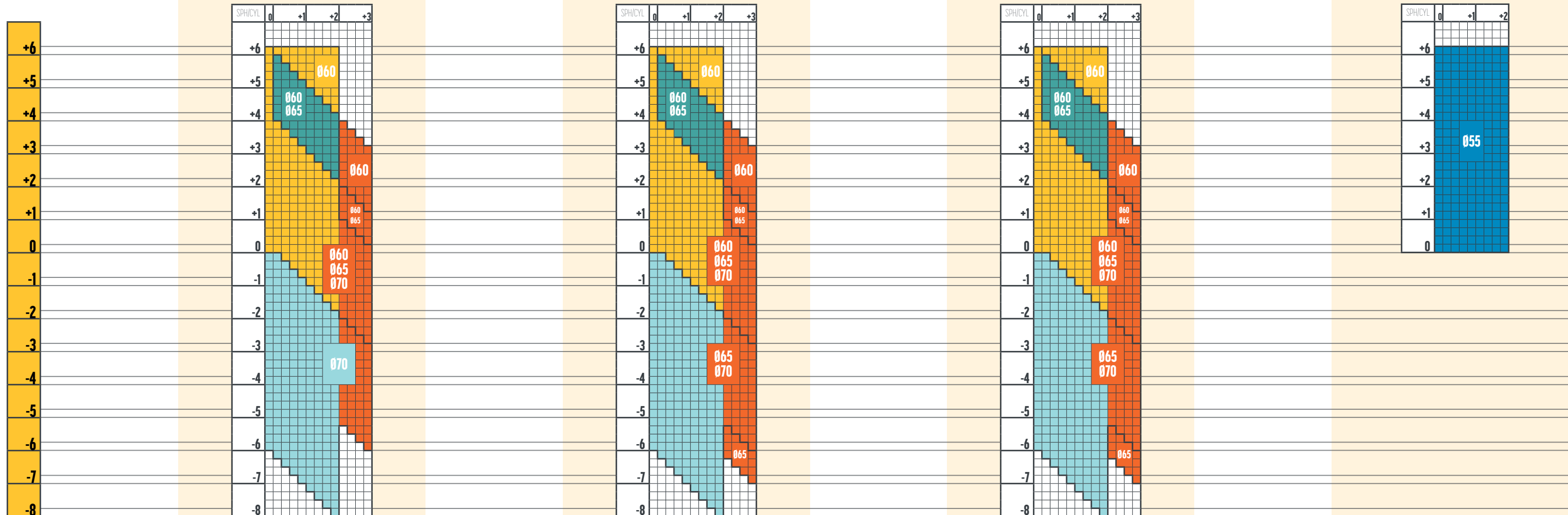

ORGANIC 1.5 ET HMC

Lentile cu margini îngroșate pentru rame cu fir.

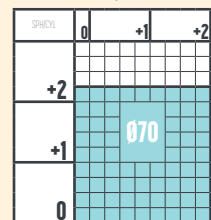

ORGANIC 1.5 ET HC

Lentile cu margini îngroșate pentru rame cu fir.

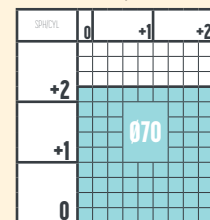

Cilindru înalt



Colorare	NU	NU	DA	NU
Tratamente disponibile	HMC	HC	UC	HMC
Tratamente adiționale	-	-	COLOR/MIRROR solid/gradient max. 85% / ULTRA ULTRA BLUE / PURE / HYDRO+ / HMC / HC / UV	-

ORGANIC STOC
LENTILE TRANSPARENTE
INDICE: 1.5

ORGANIC STOC - LENTILE FOTOCROMATICE, POLARIZANTE, COLORATE - INDICE: 1.6 / 1.56 / 1.5

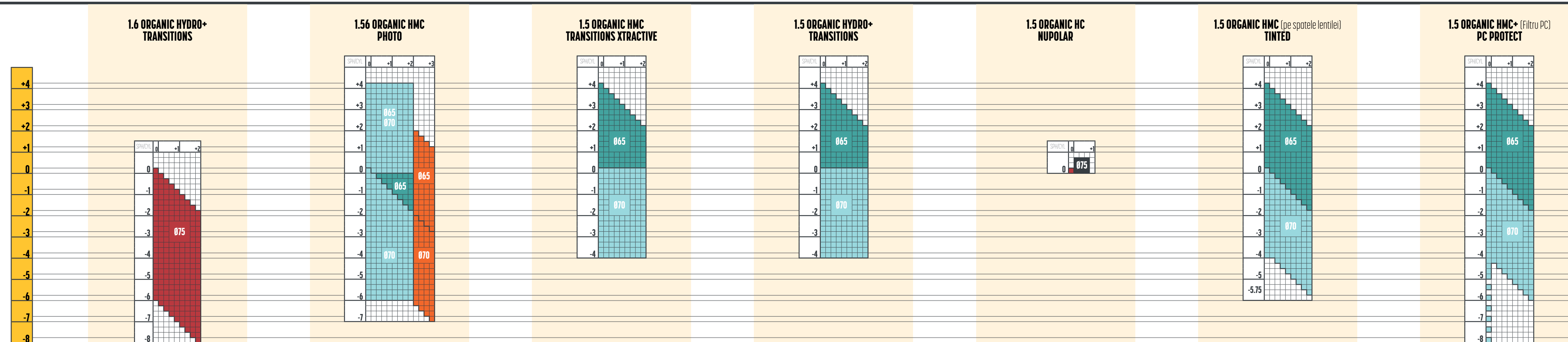

Cilindru înalt



CULORI TRANSITIONS



CULORI PHOTO



CULORI TRANSITIONS XTRACTIVE



CULORI TRANSITIONS



CULORI NUPOLAR



CULORI TINTED

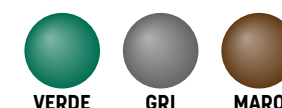

CULORI PC PROTECT



Colorare	NU	NU	NU	NU	NU	NU	NU
Tratamente disponibile	HYDRO+	HMC	HMC	HYDRO+	HC	HMC (pe spatele lentilei)	HMC+ (tratament HMC cu filtru pentru protecție PC)
Tratamente adiționale	-	-	-	-	-	-	-

ORGANIC STOC
LENTILE FOTOCROMATICE, POLARIZANTE, COLORATE
INDICE: 1.6 / 1.56 / 1.5

ORGANIC STOC BIFOCAL - LENTILE TRANSPARENTE - INDICE: 1.5; MINERAL STOC - LENTILE TRANSPARENTE, FOTOCROMATICE - INDICE: 1.5

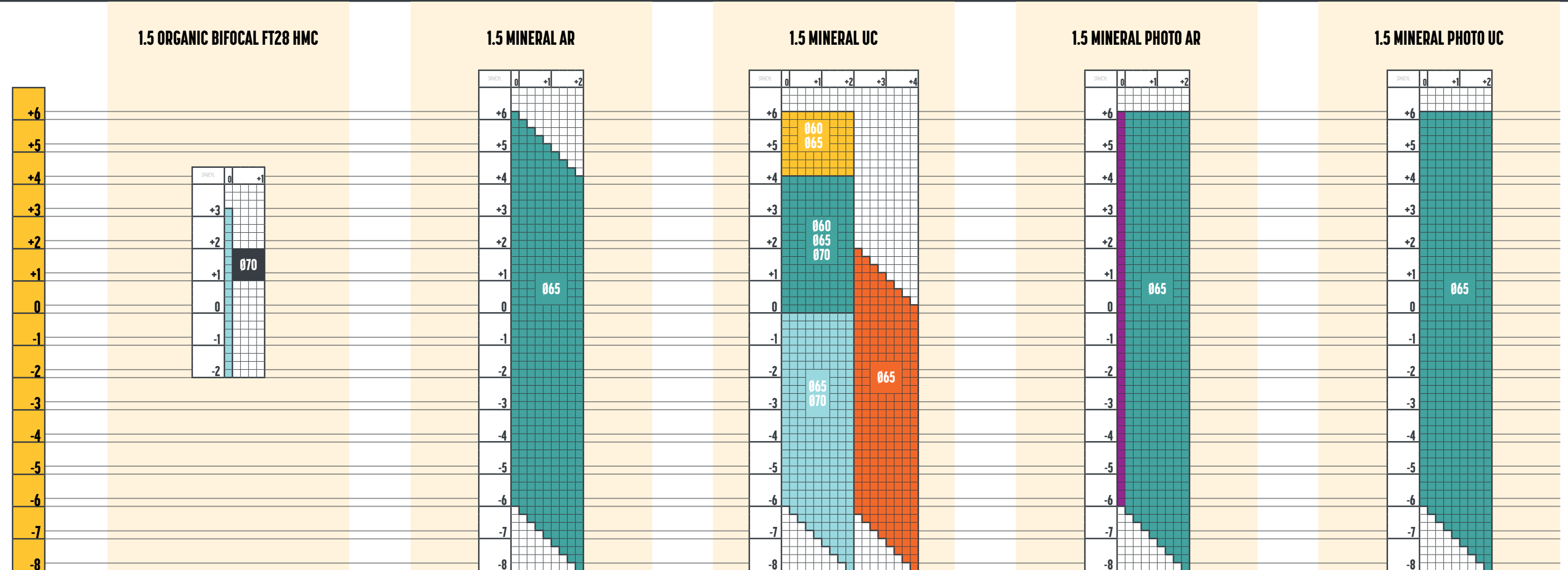

Adiție 1.00 - 3.50

Cilindru înalt

MINERAL 1.5 PHOTO GRI

 MINERAL 1.5 PHOTO MARO

CULORI PHOTO
 GRI MARO

CULORI PHOTO
 GRI MARO

Colorare	NU	NU	NU	NU	NU
Tratamente disponibile	HMC	AR	UC	AR	UC
Tratamente adiționale	-	-	-	-	-

ORGANIC STOC BIFOCAL

LENTILE TRANSPARENTE

INDICE: 1.5

MINERAL STOC

LENTILE TRANSPARENTE, FOTOCROMATICE

INDICE: 1.5

**LENTILE PROGRESIVE
CAMBER FREESTYLE
CAMBER STEADY**

1.74 CAMBER FREESTYLE
1.74 CAMBER STEADY INDIVIDUAL
1.74 CAMBER STEADY PLUS

1.67 CAMBER FREESTYLE
1.67 CAMBER STEADY INDIVIDUAL
1.67 CAMBER STEADY PLUS

1.67 CAMBER FREESTYLE
1.67 CAMBER STEADY INDIVIDUAL
1.67 CAMBER STEADY PLUS
UVAII Blue

1.6 CAMBER FREESTYLE
1.6 CAMBER STEADY INDIVIDUAL
1.6 CAMBER STEADY PLUS

1.59 POLY CAMBER FREESTYLE
1.59 POLY CAMBER STEADY INDIVIDUAL
1.59 POLY CAMBER STEADY PLUS

1.53 TRIVEX CAMBER FREESTYLE
1.53 TRIVEX CAMBER STEADY INDIVIDUAL
1.53 TRIVEX CAMBER STEADY PLUS

1.5 CAMBER FREESTYLE
1.5 CAMBER STEADY INDIVIDUAL
1.5 CAMBER STEADY PLUS

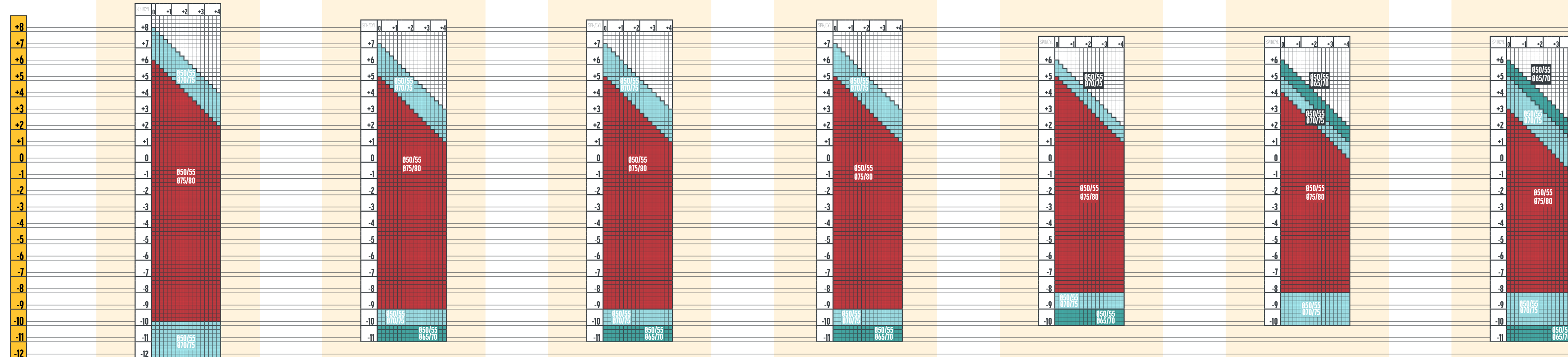

Adiție 0.50 - 4.50 / 0.25

Adiție 0.50 - 4.50 / 0.25

Adiție 0.50 - 4.50 / 0.25

Adiție 0.50 - 4.50 / 0.25

Adiție 0.50 - 4.50 / 0.25

Adiție 0.50 - 4.50 / 0.25

Adiție 0.50 - 4.50 / 0.25

Colorare	NU	DA	DA	DA	NU	NU	DA
Tratamente disponibile	ARUS BLUE / ARUS / ULTRA BLUE / ULTRA / HYDRO+ / HMC	ARUS BLUE / ARUS / ULTRA BLUE / ULTRA / HYDRO+ / HMC	ARUS BLUE / ARUS / ULTRA BLUE / ULTRA / HYDRO+ / HMC	ARUS BLUE / ARUS / ULTRA BLUE / ULTRA / HYDRO+ / HMC	ARUS BLUE / ARUS / ULTRA BLUE / ULTRA / HYDRO+ / HMC	ARUS BLUE / ARUS / ULTRA BLUE / ULTRA / HYDRO+ / HMC	ARUS BLUE / ARUS / ULTRA BLUE / ULTRA / HYDRO+ / HMC / HC
Tratamente adiționale	-	COLOR / MIRROR solid/gradient max. 85%	COLOR / MIRROR solid/gradient max. 85%	COLOR / MIRROR / PURE solid/gradient max. 85%	-	-	COLOR / MIRROR / UV / PURE solid/gradient max. 85%

CAMBER FREESTYLE
CAMBER STEADY INDIVIDUAL, CAMBER STEADY PLUS
LENTILE TRANSPARENTE
INDICE: 1.74 / 1.67 / 1.6 / 1.59 / 1.53 / 1.5

LUNGIMI PROGRESIE	
CAMBER FREESTYLE	
Lungime progresie	Înălțime montaj min. / recomandată (mm)
XS	14 / 16
XS/S	15 / 17
S	16 / 18
S/M	17 / 19
M	18 / 20
M/L	19 / 21
L	20 / 22

LUNGIMI PROGRESIE	
CAMBER STEADY IND. și PLUS	
Lungime progresie	Înălțime montaj min. / recomandată (mm)
XS	14 / 16
S	16 / 18
M	18 / 20
L	20 / 22

CAMBER FREESTYLE, CAMBER STEADY INDIVIDUAL, CAMBER STEADY PLUS - LENTILE FOTOCROMATICE - INDICE: 1.74 / 1.67 / 1.6 / 1.59 / 1.53

**1.74 CAMBER FREESTYLE
1.74 CAMBER STEADY INDIVIDUAL
1.74 CAMBER STEADY PLUS
TRANSITIONS**

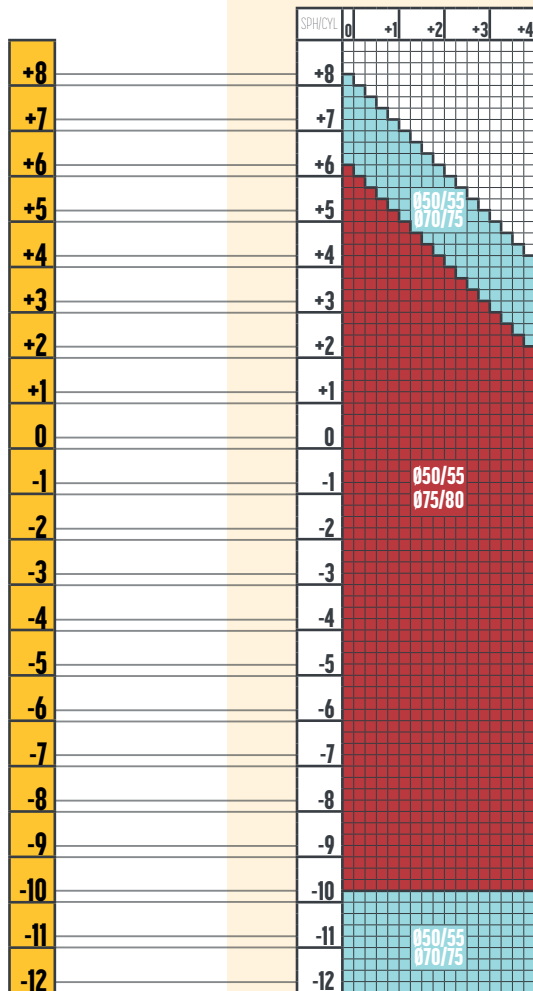

CULORI TRANSITIONS



Adiție 0.50 - 4.50 / 0.25

**1.67 CAMBER FREESTYLE
1.67 CAMBER STEADY INDIVIDUAL
1.67 CAMBER STEADY PLUS
TRANSITIONS
XTRACTIVE**

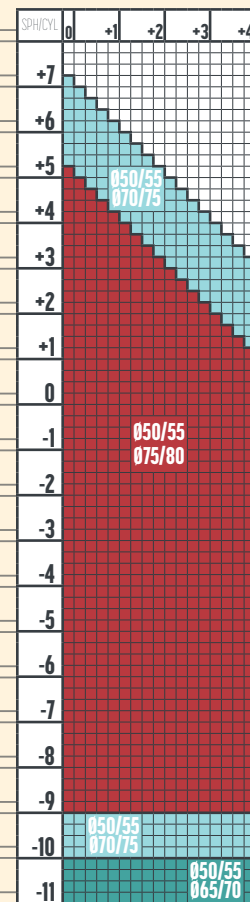

**CULORI TRANSITIONS
XTRACTIVE**



Adiție 0.50 - 4.50 / 0.25

**1.6 CAMBER FREESTYLE
1.6 CAMBER STEADY INDIVIDUAL
1.6 CAMBER STEADY PLUS
TRANSITIONS
XTRACTIVE**

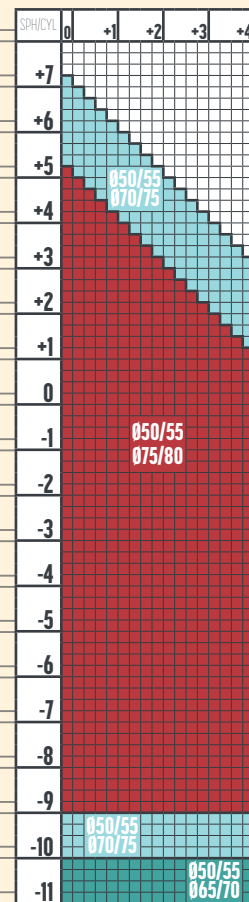

**CULORI TRANSITIONS
XTRACTIVE**



Adiție 0.50 - 4.50 / 0.25

**1.6 CAMBER FREESTYLE
1.6 CAMBER STEADY INDIVIDUAL
1.6 CAMBER STEADY PLUS
TRANSITIONS**



CULORI TRANSITIONS



Adiție 0.50 - 4.50 / 0.25

**1.59 POLY CAMBER FREESTYLE
1.59 POLY CAMBER STEADY IND.
1.59 POLY CAMBER STEADY PLUS
TRANSITIONS**

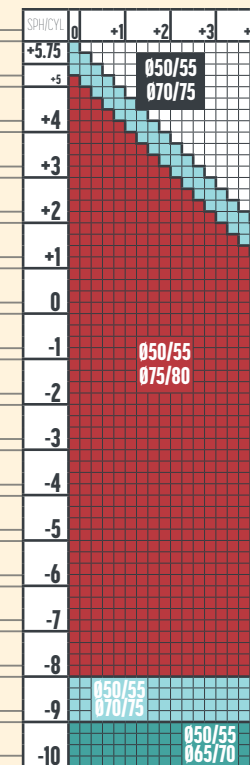

CULORI TRANSITIONS



Adiție 0.50 - 4.50 / 0.25

**1.53 TRIVEX CAMBER FREESTYLE
1.53 TRIVEX CAMBER STEADY IND.
1.53 TRIVEX CAMBER STEADY PLUS
TRANSITIONS**

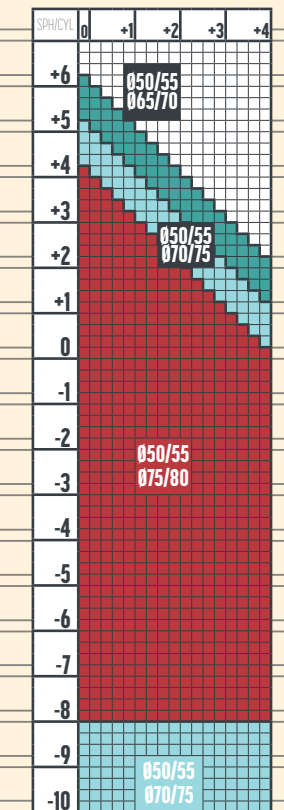

CULORI TRANSITIONS



Adiție 0.50 - 4.50 / 0.25

Colorare	NU	NU	NU	NU	NU	NU
Tratamente disponibile	ARUS BLUE / ARUS / ULTRA BLUE / ULTRA / HYDRO+ / HMC	ARUS BLUE / ARUS / ULTRA BLUE / ULTRA / HYDRO+ / HMC	ARUS BLUE / ARUS / ULTRA BLUE / ULTRA / HYDRO+ / HMC	ARUS BLUE / ARUS / ULTRA BLUE / ULTRA / HYDRO+ / HMC	ARUS BLUE / ARUS / ULTRA BLUE / ULTRA / HYDRO+ / HMC	ARUS BLUE / ARUS / ULTRA BLUE / ULTRA / HYDRO+ / HMC
Tratamente adiționale	-	-	PURE	PURE	-	-

CAMBER FREESTYLE
CAMBER STEADY INDIVIDUAL, CAMBER STEADY PLUS
LENTILE FOTOCROMATICE
INDICE: 1.74 / 1.67 / 1.6 / 1.59 / 1.53

LUNGIMI PROGRESIE	
CAMBER FREESTYLE	
Lungime progresie	Înălțime montaj min. / recomandată (mm)
XS	14 / 16
XS/S	15 / 17
S	16 / 18
S/M	17 / 19
M	18 / 20
M/L	19 / 21
L	20 / 22

LUNGIMI PROGRESIE	
CAMBER STEADY IND. și PLUS	
Lungime progresie	Înălțime montaj min. / recomandată (mm)
XS	14 / 16
S	16 / 18
M	18 / 20
L	20 / 22

CAMBER FREESTYLE, CAMBER STEADY INDIVIDUAL, CAMBER STEADY PLUS - LENTILE FOTOCROMATICE - INDICE: 1.5; LENTILE POLARIZANTE - INDICE: 1.67 / 1.6 / 1.5

**1.5 CAMBER FREESTYLE
1.5 CAMBER STEADY INDIVIDUAL
1.5 CAMBER STEADY PLUS
TRANSITIONS
TRANSITIONS XTRACTIVE**

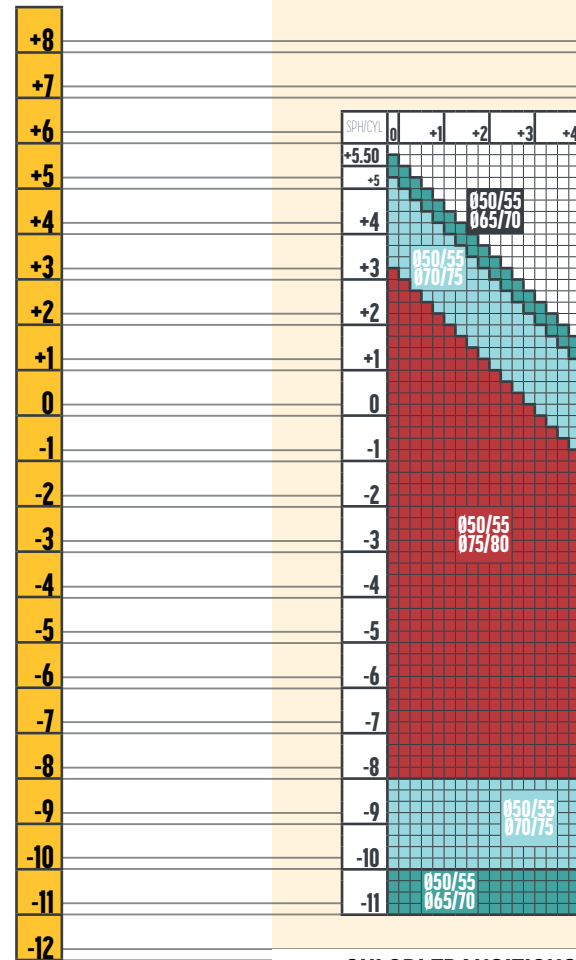

**CULORI TRANSITIONS
CULORI TRANSITIONS XTRACTIVE**



Adiție 0.50 - 4.50 / 0.25

**1.67 CAMBER FREESTYLE
1.67 CAMBER STEADY INDIVIDUAL
1.67 CAMBER STEADY PLUS
NUPOLAR**

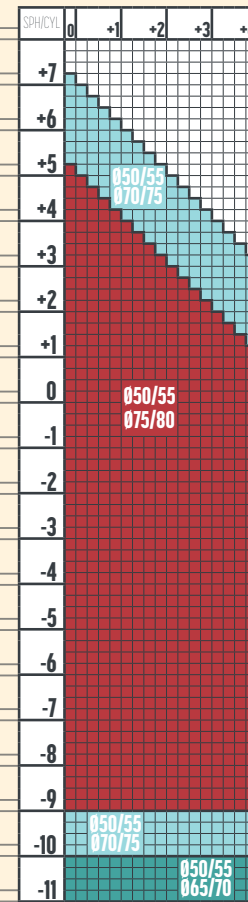

CULORI NUPOLAR



Adiție 0.50 - 4.50 / 0.25

**1.6 CAMBER FREESTYLE
1.6 CAMBER STEADY INDIVIDUAL
1.6 CAMBER STEADY PLUS
NUPOLAR**

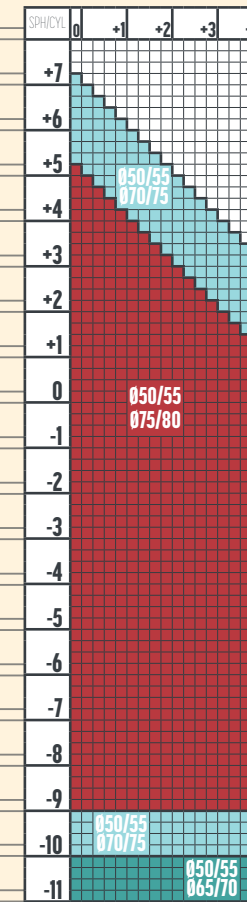

CULORI NUPOLAR



Adiție 0.50 - 4.50 / 0.25

**1.5 CAMBER FREESTYLE
1.5 CAMBER STEADY INDIVIDUAL
1.5 CAMBER STEADY PLUS
NUPOLAR**

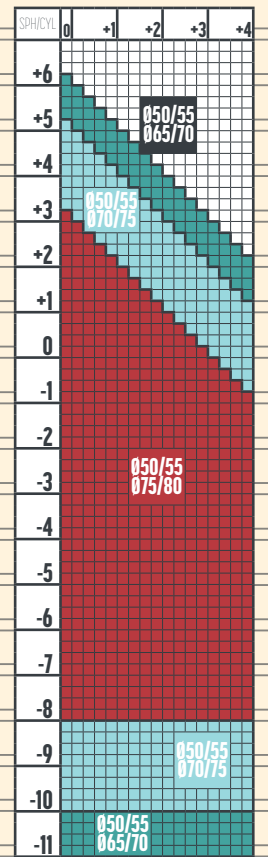

CULORI NUPOLAR



Adiție 0.50 - 4.50 / 0.25

Colorare	NU	NU	NU	NU
Tratamente disponibile	ARUS BLUE / ARUS / ULTRA BLUE / ULTRA / HYDRO+ / HMC / HC	ARUS / ULTRA / HYDRO+ / HMC	ARUS / ULTRA / HYDRO+ / HMC	ARUS / ULTRA / HYDRO+ / HMC
Tratamente adiționale	PURE	-	PURE	PURE

CAMBER FREESTYLE
CAMBER STEADY INDIVIDUAL, CAMBER STEADY PLUS
LENTILE FOTOCROMATICE
INDICE: 1.5
CAMBER FREESTYLE
CAMBER STEADY INDIVIDUAL, CAMBER STEADY PLUS
LENTILE POLARIZANTE
INDICE: 1.67 / 1.6 / 1.5

LUNGIMI PROGRESIE	
CAMBER FREESTYLE	
Lungime progresie	Înălțime montaj min. / recomandată (mm)
XS	14 / 16
XS/S	15 / 17
S	16 / 18
S/M	17 / 19
M	18 / 20
M/L	19 / 21
L	20 / 22

LUNGIMI PROGRESIE	
CAMBER STEADY IND. și PLUS	
Lungime progresie	Înălțime montaj min. / recomandată (mm)
XS	14 / 16
S	16 / 18
M	18 / 20
L	20 / 22

LENTILE PROGRESIVE INNOVATOR

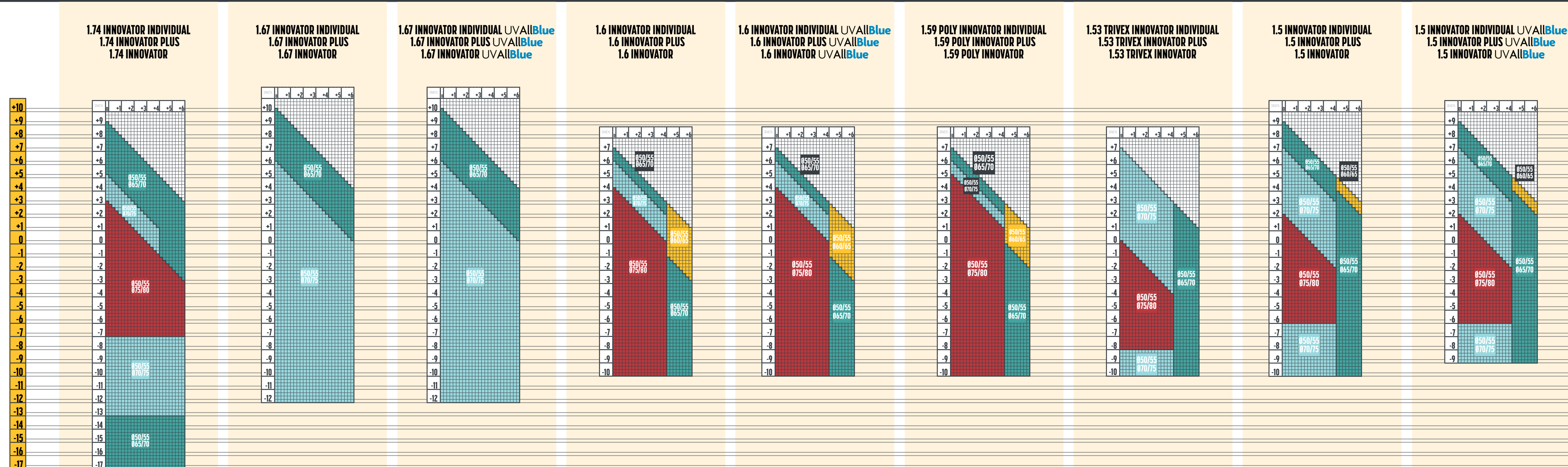

	Adiție 0.50 - 4.00 / 0.25	Adiție 0.50 - 4.00 / 0.25	Adiție 0.50 - 4.00 / 0.25	Adiție 0.50 - 4.00 / 0.25	Adiție 0.50 - 4.00 / 0.25	Adiție 0.50 - 4.00 / 0.25	Adiție 0.50 - 4.00 / 0.25	Adiție 0.50 - 4.00 / 0.25
Colorare	NU	DA	DA	DA	DA	NU	NU	DA
Tratamente disponibile	ULTRA BLUE / ULTRA / HYDRO+ / HMC	ULTRA BLUE / ULTRA / HYDRO+ / HMC	ULTRA BLUE / ULTRA / HYDRO+ / HMC	ULTRA BLUE / ULTRA / HYDRO+ / HMC / HC (doar pentru Plus și Simplu)	ULTRA BLUE / ULTRA / HYDRO+ / HMC / HC (doar pentru Plus și Simplu)	ULTRA BLUE / ULTRA / HYDRO+ / HMC	ULTRA BLUE / ULTRA / HYDRO+ / HMC / HC (doar pentru Plus și Simplu)	ULTRA BLUE / ULTRA / HYDRO+ / HMC / HC și UC (doar pentru Plus și Simplu)
Tratamente adiționale	-	COLOR / MIRROR solid/gradient max. 85%	COLOR / MIRROR solid/gradient max. 85%	COLOR / MIRROR / PURE solid/gradient max. 85%	COLOR / MIRROR / PURE solid/gradient max. 85%	-	-	COLOR / MIRROR / PURE / UV solid/gradient max. 85%

1.74 INNOVATOR INDIVIDUAL TINT
1.74 INNOVATOR PLUS TINT
1.74 INNOVATOR TINT

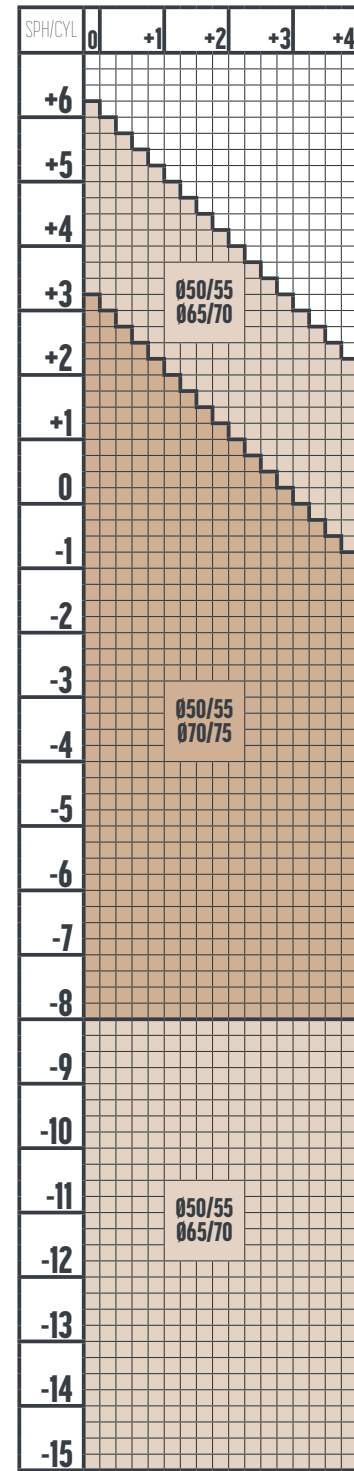

INNOVATOR INDIVIDUAL, INNOVATOR PLUS, INNOVATOR
LENTILE TRANSPARENTE
INDICE: 1.74 / 1.67 / 1.6 / 1.59 / 1.53 / 1.5

LUNGIMI PROGRESIE	
INNOVATOR INDIVIDUAL, INNOVATOR PLUS, INNOVATOR	
Lungime progresie	Înălțime montaj min. / recomandată (mm)
XS	14 / 16
S	16 / 18
M	18 / 20
L	20 / 22

Dioptrii care se pot colora,
conform diametrelor.

1.74 INNOVATOR INDIVIDUAL
1.74 INNOVATOR PLUS
1.74 INNOVATOR
TRANSITIONS

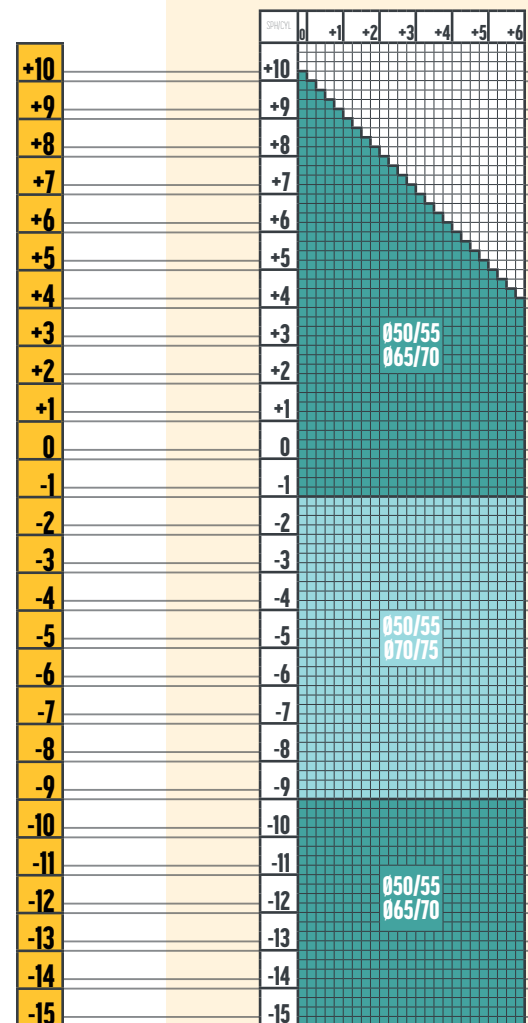

CULORI TRANSITIONS



Adiție 0.50 - 4.00 / 0.25

1.67 INNOVATOR INDIVIDUAL
1.67 INNOVATOR PLUS
1.67 INNOVATOR
TRANSITIONS
XTRACTIVE

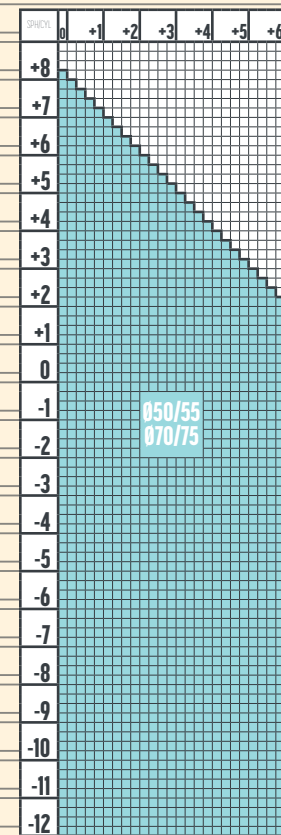

CULORI TRANSITIONS XTRACTIVE

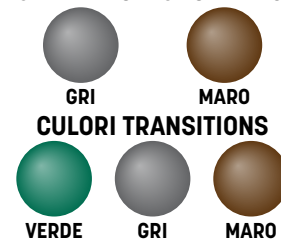

Adiție 0.50 - 4.00 / 0.25

1.6 INNOVATOR INDIVIDUAL
1.6 INNOVATOR PLUS
1.6 INNOVATOR
TRANSITIONS
XTRACTIVE

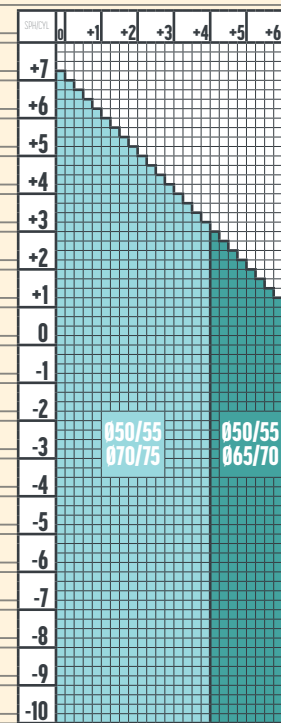

CULORI TRANSITIONS XTRACTIVE

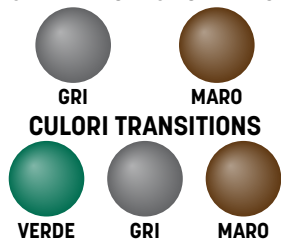

Adiție 0.50 - 4.00 / 0.25

1.59 POLY INNOVATOR INDIVIDUAL
1.59 POLY INNOVATOR PLUS
1.59 POLY INNOVATOR
TRANSITIONS XTRACTIVE

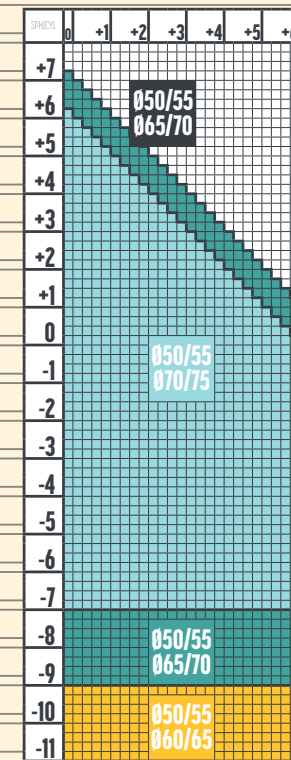

CULORI TRANSITIONS XTRACTIVE



Adiție 0.50 - 4.00 / 0.25

1.59 POLY INNOVATOR INDIVIDUAL
1.59 POLY INNOVATOR PLUS
1.59 POLY INNOVATOR
TRANSITIONS

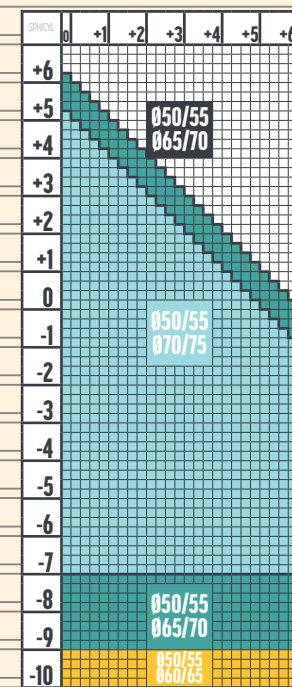

CULORI TRANSITIONS



Adiție 0.50 - 4.00 / 0.25

1.56 INNOVATOR INDIVIDUAL
1.56 INNOVATOR PLUS
1.56 INNOVATOR
PHOTO

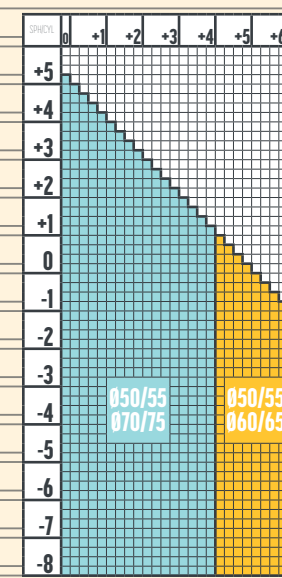

CULORI PHOTO



Adiție 0.50 - 4.00 / 0.25

1.53 TRIVEX INNOVATOR INDIVIDUAL
1.53 TRIVEX INNOVATOR PLUS
1.53 TRIVEX INNOVATOR
TRANSITIONS XTRACTIVE

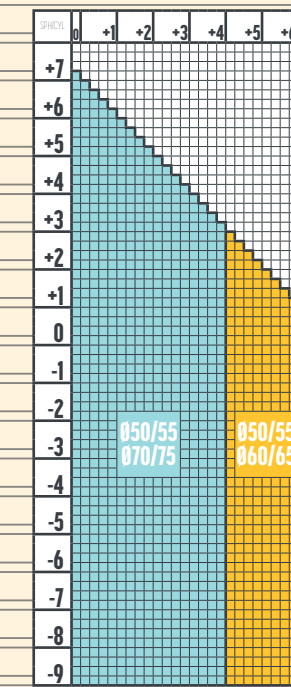

CULORI TRANSITIONS XTRACTIVE



Adiție 0.50 - 4.00 / 0.25

1.53 TRIVEX INNOVATOR INDIVIDUAL
1.53 TRIVEX INNOVATOR PLUS
1.53 TRIVEX INNOVATOR
TRANSITIONS

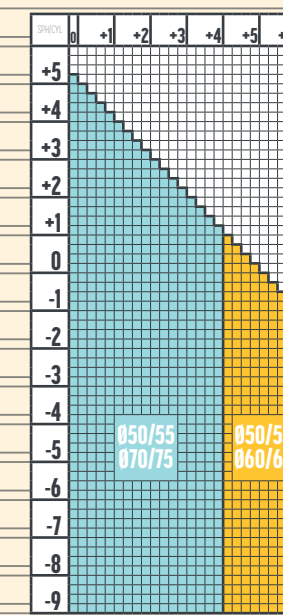

CULORI TRANSITIONS



Adiție 0.50 - 4.00 / 0.25

1.5 INNOVATOR INDIVIDUAL
1.5 INNOVATOR PLUS
1.5 INNOVATOR
TRANSITIONS
XTRACTIVE

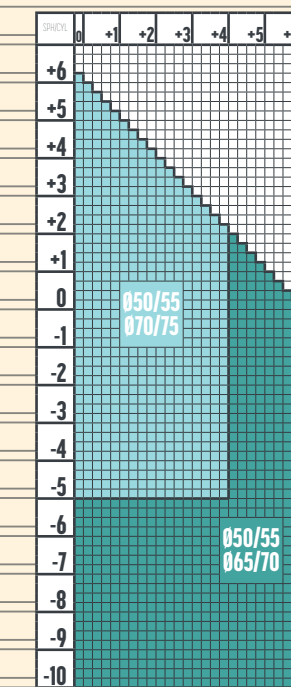

CULORI TRANSITIONS XTRACTIVE



Adiție 0.50 - 4.00 / 0.25

Colorare	NU	NU	NU	NU	NU	NU	NU	NU	NU	
Tratamente disponibile	ULTRA BLUE / ULTRA / HYDRO+ / HMC	ULTRA BLUE / ULTRA / HYDRO+ / HMC	ULTRA BLUE / ULTRA / HYDRO+ / HMC / HC (doar pentru Plus și Simplu)	ULTRA BLUE / ULTRA / HYDRO+ / HMC / HC (doar pentru Plus și Simplu)	ULTRA BLUE / ULTRA / HYDRO+ / HMC / HC (doar pentru Plus și Simplu)	ULTRA BLUE / ULTRA / HYDRO+ / HMC / HC (doar pentru Plus și Simplu)	ULTRA BLUE / ULTRA / HYDRO+ / HMC / HC (doar pentru Plus și Simplu)	ULTRA BLUE / ULTRA / HYDRO+ / HMC / HC (doar pentru Plus și Simplu)	ULTRA BLUE / ULTRA / HYDRO+ / HMC / HC (doar pentru Plus și Simplu)	ULTRA BLUE / ULTRA / HYDRO+ / HMC / HC (doar pentru Plus și Simplu)
Tratamente adiționale	-	-	PURE	-	-	-	-	-	-	PURE

INNOVATOR INDIVIDUAL, INNOVATOR PLUS, INNOVATOR
LENTILE FOTOCROMATICE
INDICE: 1.74 / 1.67 / 1.6 / 1.59 / 1.56 / 1.53 / 1.5

LUNGIMI PROGRESIE INNOVATOR INDIVIDUAL, INNOVATOR PLUS, INNOVATOR	
Lungime progresie	Înălțime montaj min. / recomandată (mm)
XS	14 / 16
S	16 / 18
M	18 / 20
L	20 / 22

**1.67 INNOVATOR INDIVIDUAL
1.67 INNOVATOR PLUS
1.67 INNOVATOR
NUPOLAR**

**1.6 INNOVATOR INDIVIDUAL
1.6 INNOVATOR PLUS
1.6 INNOVATOR
NUPOLAR**

**1.59 POLY INNOVATOR INDIVIDUAL
1.59 POLY INNOVATOR PLUS
1.59 POLY INNOVATOR
TRANSITIONS DRIVEWEAR**

**1.59 POLY INNOVATOR INDIVIDUAL
1.59 POLY INNOVATOR PLUS
1.59 POLY INNOVATOR
NUPOLAR**

**1.53 TRIVEX INNOVATOR INDIVIDUAL
1.53 TRIVEX INNOVATOR PLUS
1.53 TRIVEX INNOVATOR
NUPOLAR**

**1.5 INNOVATOR INDIVIDUAL
1.5 INNOVATOR PLUS
1.5 INNOVATOR
TRANSITIONS DRIVEWEAR**

**1.5 INNOVATOR INDIVIDUAL
1.5 INNOVATOR PLUS
1.5 INNOVATOR
NUPOLAR**

+8
+7
+6
+5
+4
+3
+2
+1
0
-1
-2
-3
-4
-5
-6
-7
-8
-9
-10
-11
-12

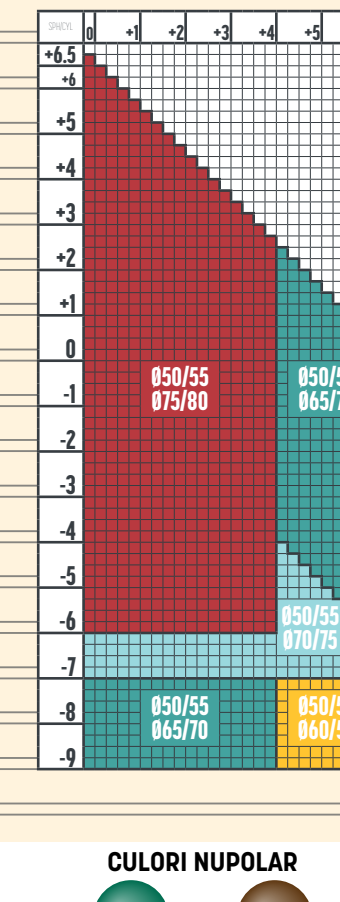
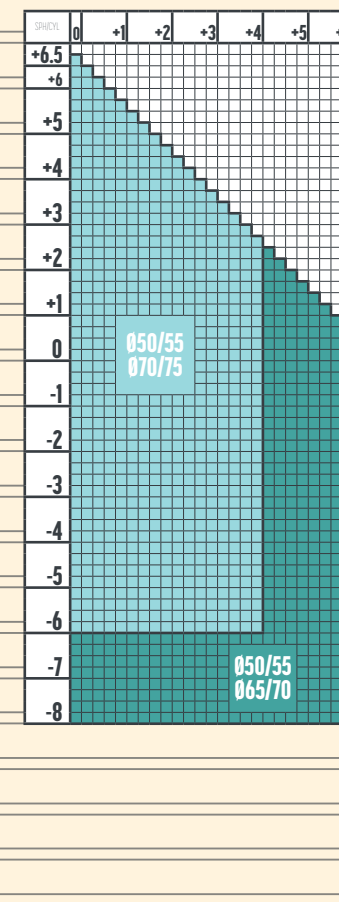
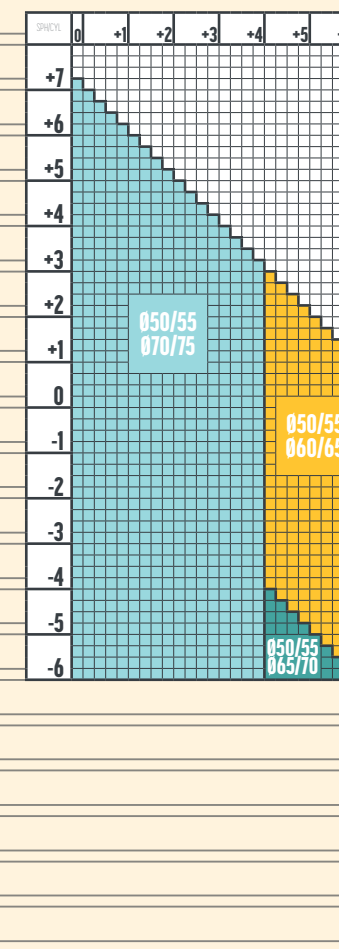
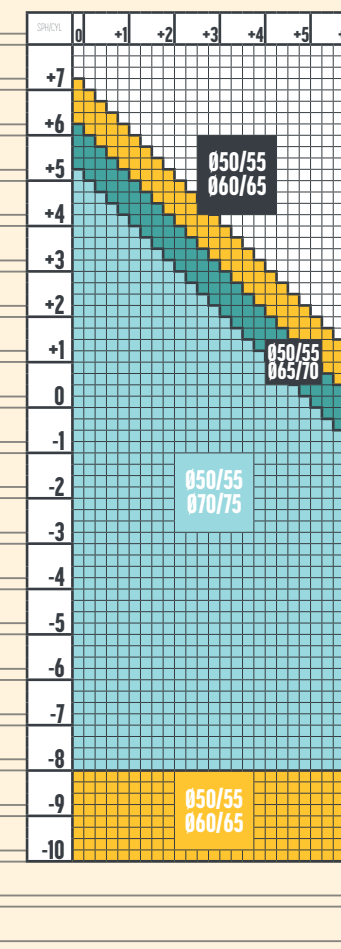
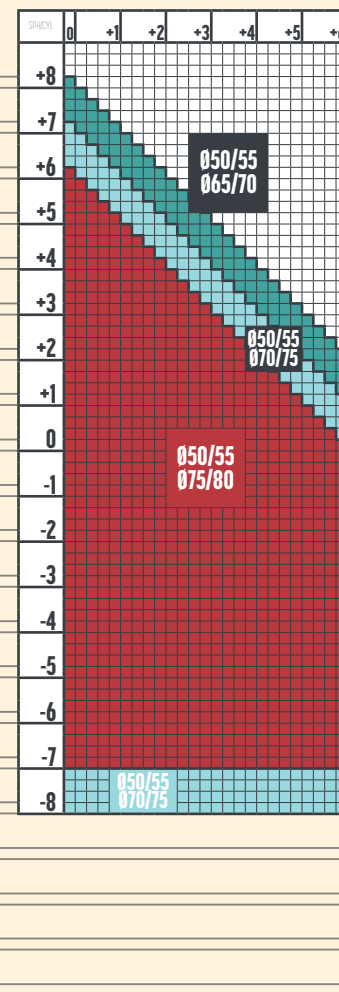
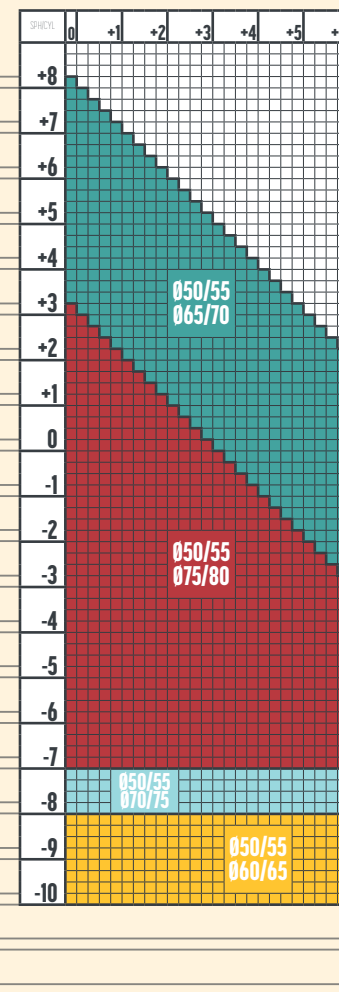
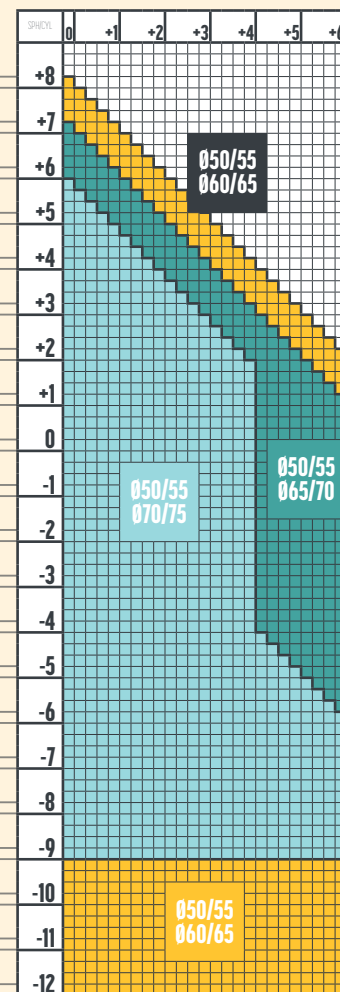

CULORI NUPOLAR
VERDE G15 GRI3 MARO
Adiție 0.50 - 4.00 / 0.25

CULORI NUPOLAR
VERDE G15 GRI3 MARO
Adiție 0.50 - 4.00 / 0.25

Adiție 0.50 - 4.00 / 0.25

CULORI NUPOLAR
VERDE G15 GRI3 INFINITE GREY MARO
Adiție 0.50 - 4.00 / 0.25

CULORI NUPOLAR
GRI3 MARO
Adiție 0.50 - 4.00 / 0.25

Adiție 0.50 - 4.00 / 0.25

CULORI NUPOLAR
VERDE G15 MARO
GRI1 GRI3 INFINITE GREY
Adiție 0.50 - 4.00 / 0.25

Colorare	NU	NU	NU	NU	NU	NU	NU
Tratamente disponibile	ULTRA / HYDRO+ / HMC	ULTRA / HYDRO+ / HMC	ULTRA / HYDRO+ / HMC / HC (doar pentru Plus si Simplu)	ULTRA / HYDRO+ / HMC / HC (doar pentru Plus si Simplu)	ULTRA / HYDRO+ / HMC / HC (doar pentru Plus si Simplu)	ULTRA / HYDRO+ / HMC / HC (doar pentru Plus si Simplu)	ULTRA / HYDRO+ / HMC / HC (doar pentru Plus si Simplu)
Tratamente adiționale	-	PURE	-	-	-	PURE	PURE

INNOVATOR INDIVIDUAL, INNOVATOR PLUS, INNOVATOR
LENTILE POLARIZANTE
INDICE: 1.67 / 1.6 / 1.59 / 1.53 / 1.5

LUNGIMI PROGRESIE INNOVATOR INDIVIDUAL, INNOVATOR PLUS, INNOVATOR	
Lungime progresie	Înălțime montaj min. / recomandată (mm)
XS	14 / 16
S	16 / 18
M	18 / 20
L	20 / 22

INNOVATOR MINERAL - LENTILE TRANSPARENTE, FOTOCROMATICE - INDICE: 1.6 / 1.5

1.6 INNOVATOR MINERAL

1.6 INNOVATOR MINERAL PHOTO

1.5 INNOVATOR MINERAL

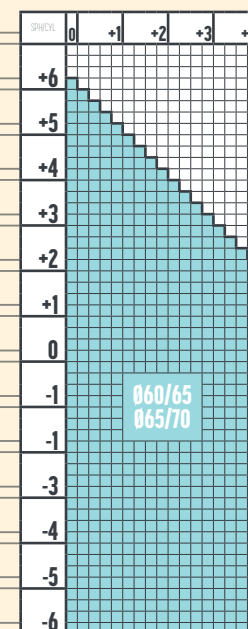
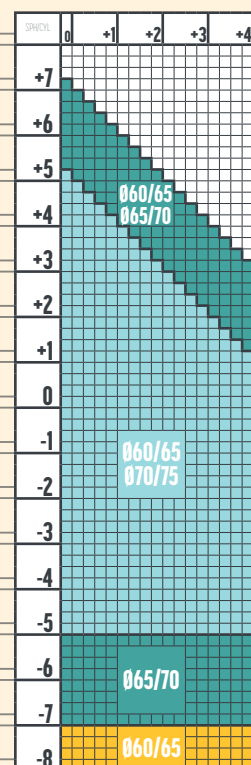
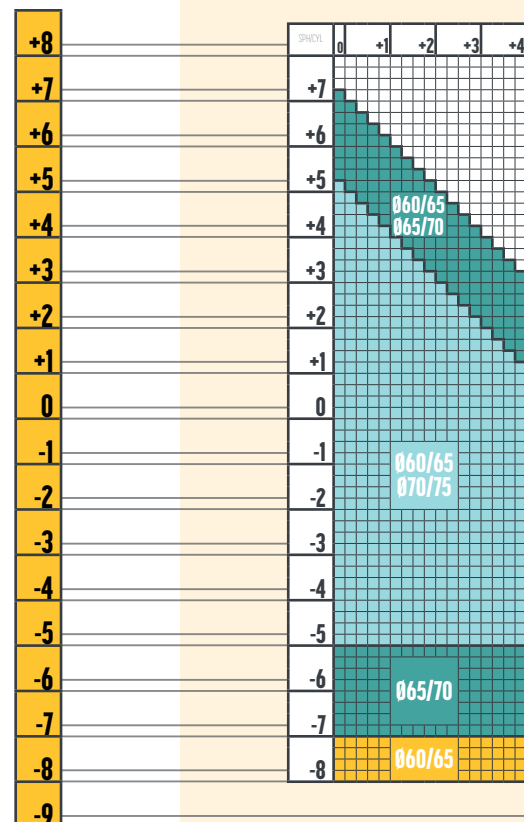

CULORI PHOTO



MARO

Adiție 0.75 - 3.50 / 0.25

Adiție 0.75 - 3.50 / 0.25

Adiție 1.00 - 3.00 / 0.25

Colorare	DA	NU	DA
Tratamente disponibile	ULTRA / HYDRO+ / AR (disponibil și UC)	ULTRA / HYDRO+ / AR (disponibil și UC)	ULTRA / HYDRO+ / AR (disponibil și UC)
Tratamente adiționale	-	-	-

Colorare disponibilă

Culoare	Procentaj colorare
GRI SOLID	25%
GRI SOLID	50%
GRI SOLID	75%
MARO SOLID / GRADIENT	15%
MARO SOLID / GRADIENT	25%
MARO SOLID / GRADIENT	50%
MARO SOLID / GRADIENT	75%

LUNGIMI PROGRESIE INNOVATOR MINERAL

Lungime progresie	Înălțime montaj min. / recomandată (mm)
M	18 / 21

INNOVATOR MINERAL
LENTILE TRANSPARENTE, FOTOCROMATICE
INDICE: 1.6 / 1.5

LENTILE PROGRESIVE FACILE

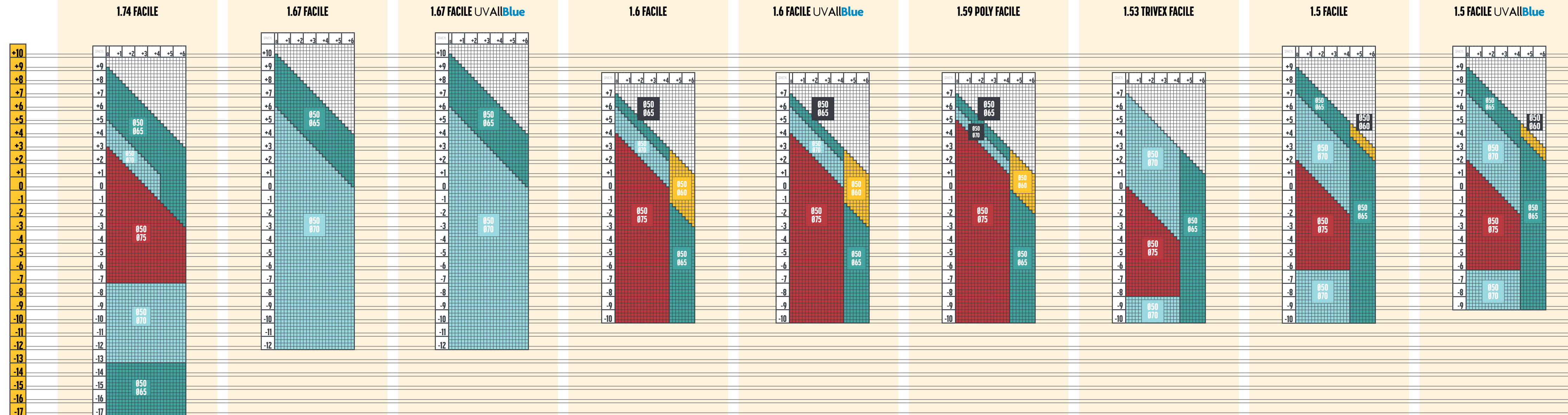

	1.74 FACILE	1.67 FACILE	1.67 FACILE UVAiIbLue	1.6 FACILE	1.6 FACILE UVAiIbLue	1.59 POLY FACILE	1.53 TRIVEX FACILE	1.5 FACILE	1.5 FACILE UVAiIbLue
Adiție 0.50, 0.75, 1.00	Adiție 0.50, 0.75, 1.00	Adiție 0.50, 0.75, 1.00	Adiție 0.50, 0.75, 1.00	Adiție 0.50, 0.75, 1.00	Adiție 0.50, 0.75, 1.00	Adiție 0.50, 0.75, 1.00	Adiție 0.50, 0.75, 1.00	Adiție 0.50, 0.75, 1.00	Adiție 0.50, 0.75, 1.00
Colorare	NU	DA	DA	DA	DA	NU	NU	DA	DA
Tratamente disponibile	ULTRA BLUE / ULTRA / HYDRO+ / HMC	ULTRA BLUE / ULTRA / HYDRO+ / HMC	ULTRA BLUE / ULTRA / HYDRO+ / HMC	ULTRA BLUE / ULTRA / HYDRO+ / HMC / HC	ULTRA BLUE / ULTRA / HYDRO+ / HMC / HC	ULTRA BLUE / ULTRA / HYDRO+ / HMC	ULTRA BLUE / ULTRA / HYDRO+ / HMC / HC	ULTRA BLUE / ULTRA / HYDRO+ / HMC / HC / UC	ULTRA BLUE / ULTRA / HYDRO+ / HMC / HC
Tratamente adiționale	-	COLOR / MIRROR solid/gradient max. 85%	COLOR / MIRROR solid/gradient max. 85%	COLOR / MIRROR / PURE solid/gradient max. 85%	COLOR / MIRROR / PURE solid/gradient max. 85%	-	-	COLOR / MIRROR / PURE / UV solid/gradient max. 85%	COLOR / MIRROR / PURE solid/gradient max. 85%



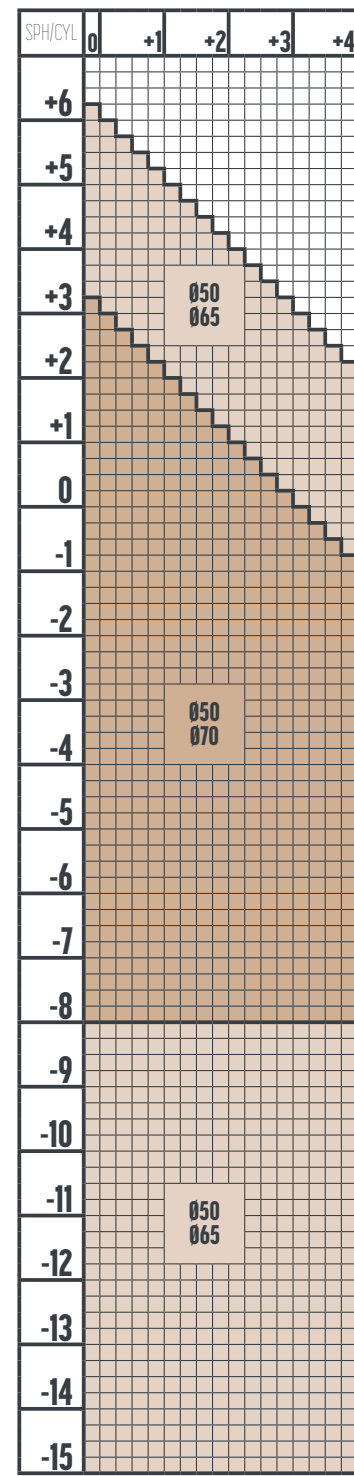





1.74 FACILE TINT

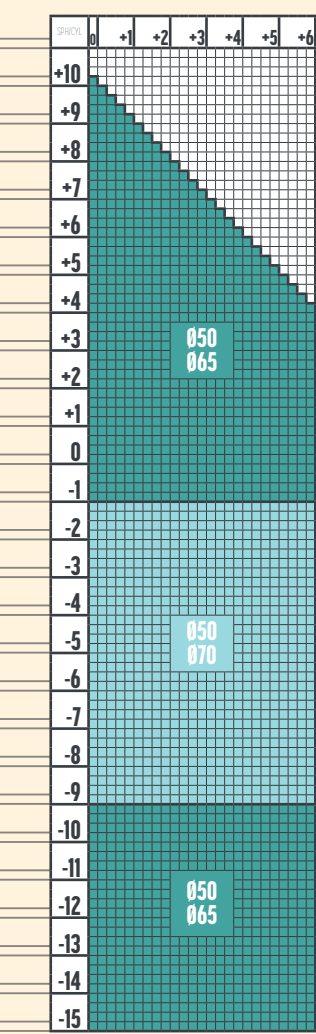
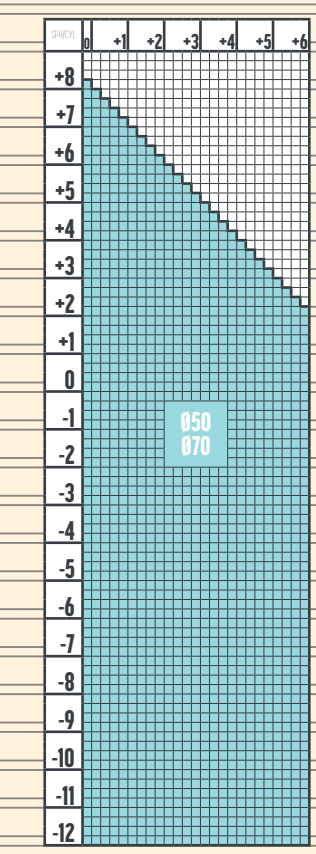
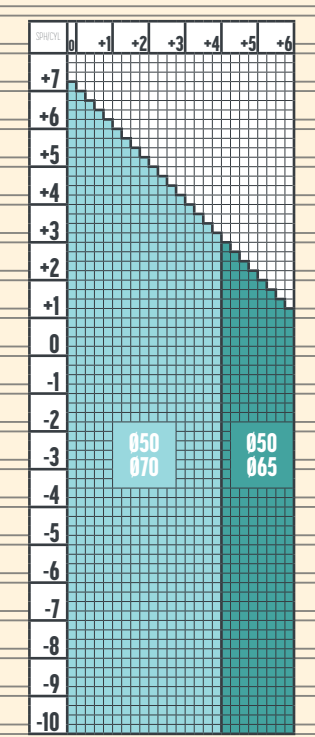
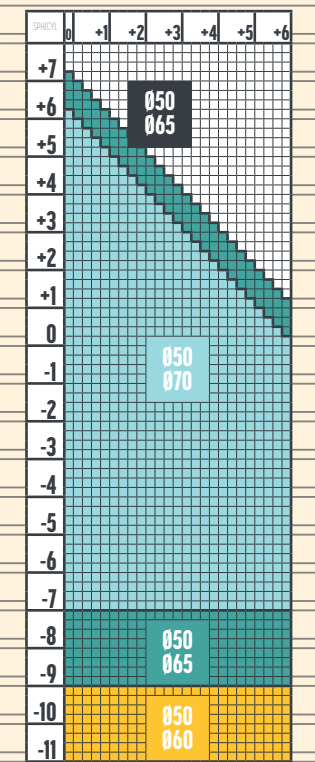
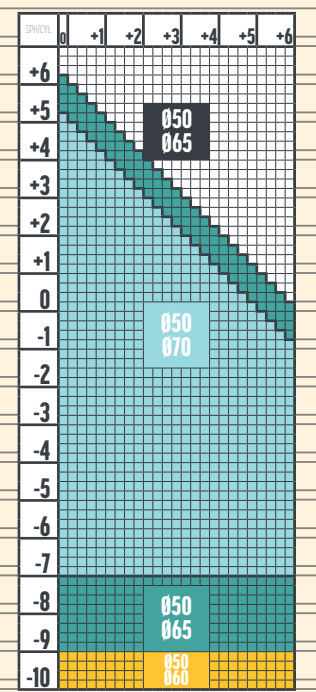
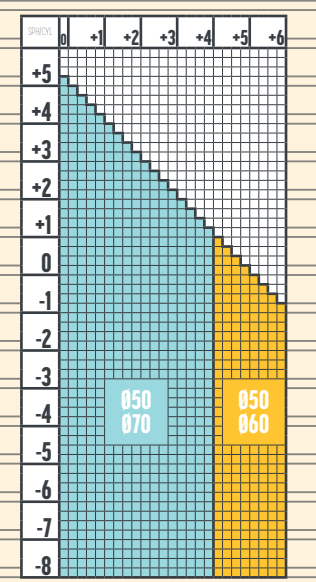
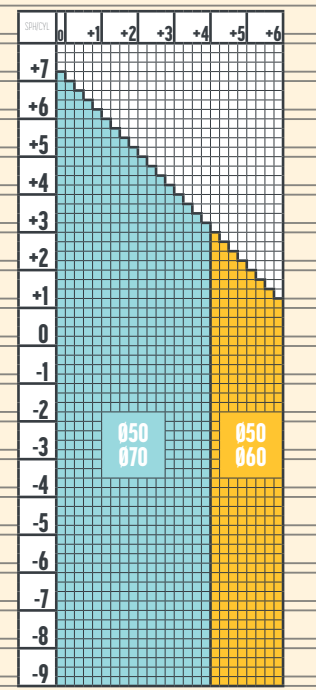
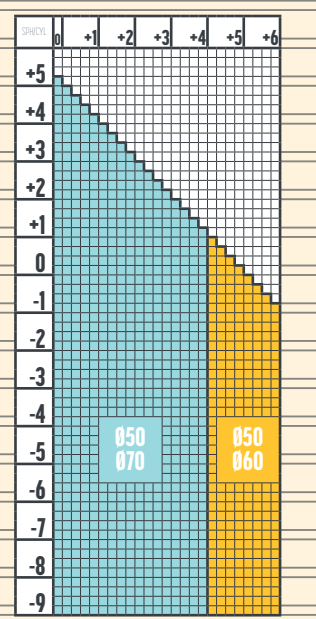
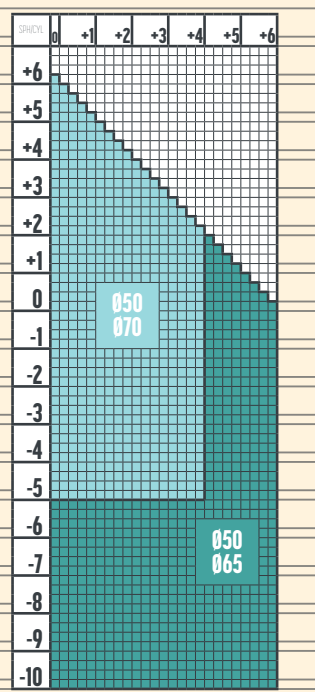

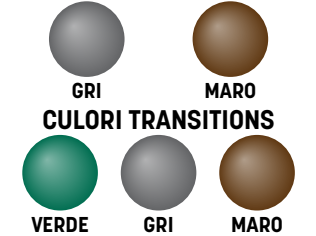
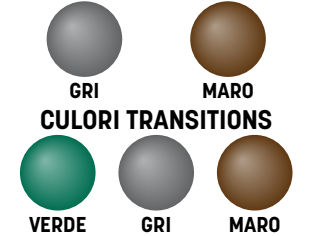
FACILE
LENTILE TRANSPARENTE
INDICE: 1.74 / 1.67 / 1.6 / 1.59 / 1.53 / 1.5

LUNGIMI PROGRESIE FACILE	
Lungime progresie	Înălțime montaj min. / recomandată (mm)
XS	14 / 16

Dioptrii care se pot colora, conform diametrelor.

	1.74 FACILE TRANSITIONS	1.67 FACILE TRANSITIONS 1.67 FACILE TRANSITIONS XTRACTIVE	1.6 FACILE TRANSITIONS 1.6 FACILE TRANSITIONS XTRACTIVE	1.59 POLY FACILE TRANSITIONS XTRACTIVE	1.59 POLY FACILE TRANSITIONS	1.56 FACILE PHOTO	1.53 TRIVEX FACILE TRANSITIONS XTRACTIVE	1.53 TRIVEX FACILE TRANSITIONS	1.5 FACILE TRANSITIONS 1.5 FACILE TRANSITIONS XTRACTIVE
									
	COLORI TRANSITIONS  Adiție 0.50, 0.75, 1.00	COLORI TRANSITIONS XTRACTIVE  Adiție 0.50, 0.75, 1.00	COLORI TRANSITIONS XTRACTIVE  Adiție 0.50, 0.75, 1.00	COLORI TRANSITIONS XTRACTIVE  Adiție 0.50, 0.75, 1.00	COLORI TRANSITIONS  Adiție 0.50, 0.75, 1.00	COLORI PHOTO  Adiție 0.50, 0.75, 1.00	COLORI TRANSITIONS XTRACTIVE  Adiție 0.50, 0.75, 1.00	COLORI TRANSITIONS  Adiție 0.50, 0.75, 1.00	COLORI TRANSITIONS XTRACTIVE  Adiție 0.50, 0.75, 1.00
Colorare	NU	NU	NU	NU	NU	NU	NU	NU	NU
Tratamente disponibile	ULTRA BLUE / ULTRA / HYDRO+ / HMC	ULTRA BLUE / ULTRA / HYDRO+ / HMC	ULTRA BLUE / ULTRA / HYDRO+ / HMC / HC	ULTRA BLUE / ULTRA / HYDRO+ / HMC / HC	ULTRA BLUE / ULTRA / HYDRO+ / HMC / HC	ULTRA BLUE / ULTRA / HYDRO+ / HMC / HC	ULTRA BLUE / ULTRA / HYDRO+ / HMC / HC	ULTRA BLUE / ULTRA / HYDRO+ / HMC / HC	ULTRA BLUE / ULTRA / HYDRO+ / HMC / HC
Tratamente adiționale	-	-	PURE	-	-	-	-	-	PURE

FACILE
LENTILE FOTOCROMATICE
INDICE: 1.74 / 1.67 / 1.6 / 1.59 / 1.56 / 1.53 / 1.5

LUNGIMI PROGRESIE FACILE	
Lungime progresie	Înălțime montaj min. / recomandată (mm)
XS	14 / 16

**1.67 FACILE
NUPOLAR**

**1.6 FACILE
NUPOLAR**

**1.59 POLY FACILE
TRANSITIONS DRIVEWEAR**

**1.59 POLY FACILE
NUPOLAR**

**1.53 TRIVEX FACILE
NUPOLAR**

**1.5 FACILE
TRANSITIONS DRIVEWEAR**

**1.5 FACILE
NUPOLAR**

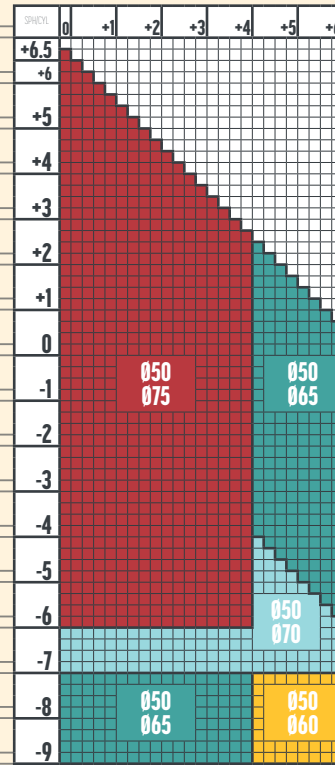
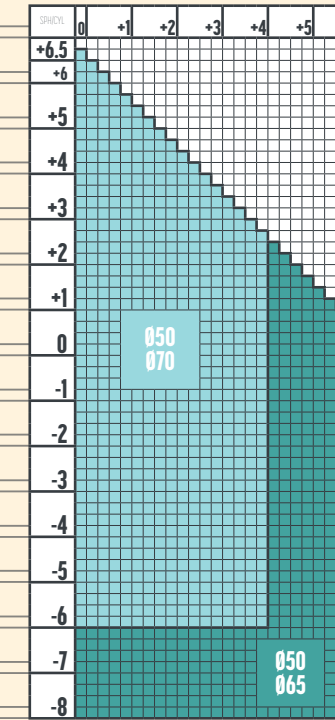
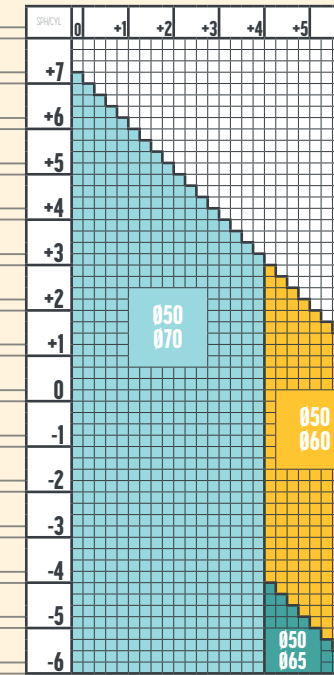
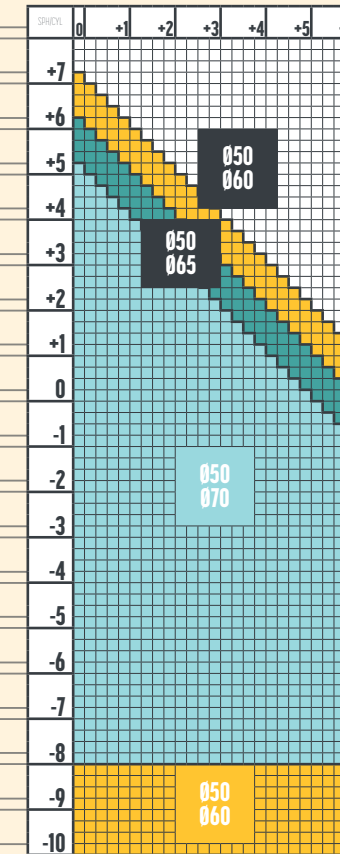
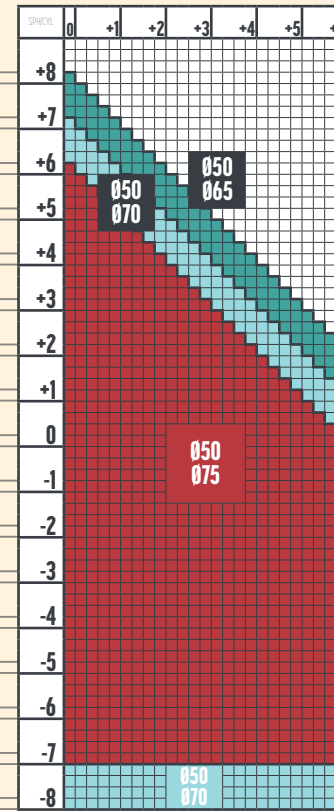
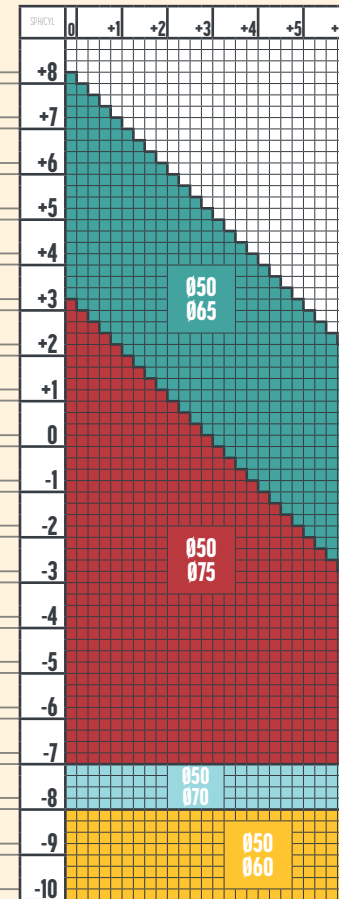
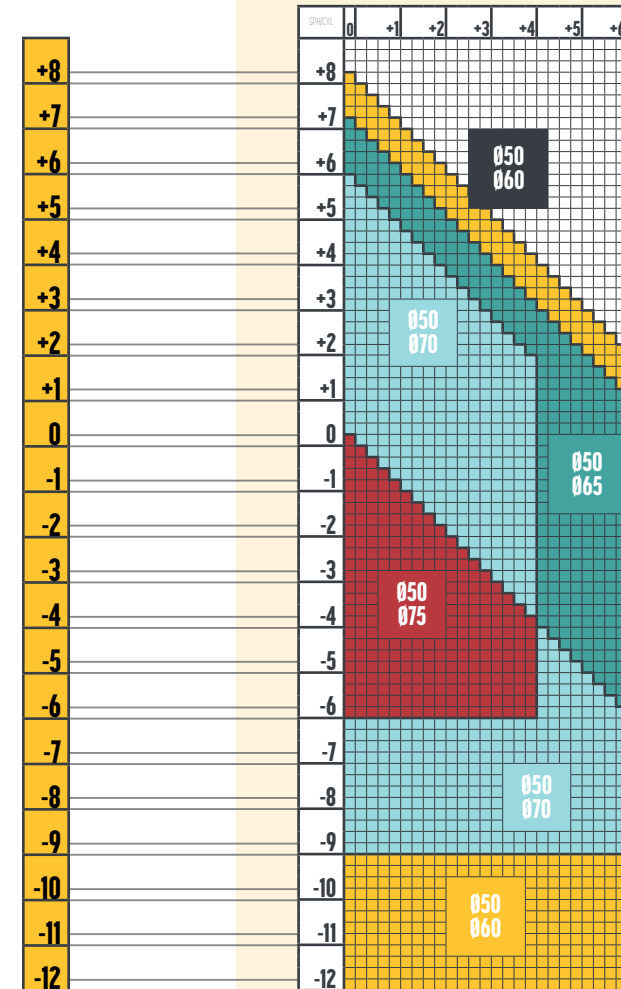

CULORI NUPOLAR
VERDE G15 GRI3 MARO
Adiție 0.50, 0.75, 1.00

CULORI NUPOLAR
VERDE G15 GRI3 MARO
Adiție 0.50, 0.75, 1.00

Adiție 0.50, 0.75, 1.00

CULORI NUPOLAR
VERDE G15 GRI3 INFINITE GREY MARO
Adiție 0.50, 0.75, 1.00

CULORI NUPOLAR
GRI3 MARO
Adiție 0.50, 0.75, 1.00

Adiție 0.50, 0.75, 1.00

CULORI NUPOLAR
VERDE G15 MARO
GRI1 GRI3 INFINITE GREY
Adiție 0.50, 0.75, 1.00

Colorare	NU	NU	NU	NU	NU	NU	NU
Tratamente disponibile	ULTRA / HYDRO+ / HMC	ULTRA / HYDRO+ / HMC	ULTRA / HYDRO+ / HMC / HC	ULTRA / HYDRO+ / HMC / HC	ULTRA / HYDRO+ / HMC / HC	ULTRA / HYDRO+ / HMC / HC	ULTRA / HYDRO+ / HMC / HC
Tratamente adiționale	-	PURE	-	-	-	PURE	PURE

FACILE
LENTILE POLARIZANTE
INDICE: 1.67 / 1.6 / 1.59 / 1.53 / 1.5

LUNGIMI PROGRESIE FACILE	
Lungime progresie	Înălțime montaj min. / recomandată (mm)
XS	14 / 16

**LENTILE INNOVATOR DEGRESIV
HOME, OFFICE, DESKTOP, COMPUTER**

1.74 INNOVATOR DEGRESIV HOME, OFFICE, DESKTOP, COMPUTER

1.67 INNOVATOR DEGRESIV HOME, OFFICE, DESKTOP, COMPUTER

1.67 INNOVATOR DEGRESIV UVAILBlue HOME, OFFICE, DESKTOP, COMPUTER

1.6 INNOVATOR DEGRESIV HOME, OFFICE, DESKTOP, COMPUTER

1.6 INNOVATOR DEGRESIV UVAILBlue HOME, OFFICE, DESKTOP, COMPUTER

1.59 POLY INNOVATOR DEGRESIV HOME, OFFICE, DESKTOP, COMPUTER

1.53 TRIVEX INNOVATOR DEGRESIV HOME, OFFICE, DESKTOP, COMPUTER

1.5 INNOVATOR DEGRESIV HOME, OFFICE, DESKTOP, COMPUTER

1.5 INNOVATOR DEGRESIV UVAILBlue HOME, OFFICE, DESKTOP, COMPUTER

+10
+9
+8
+7
+6
+5
+4
+3
+2
+1
0
-1
-2
-3
-4
-5
-6
-7
-8
-9
-10
-11
-12
-13
-14
-15
-16
-17

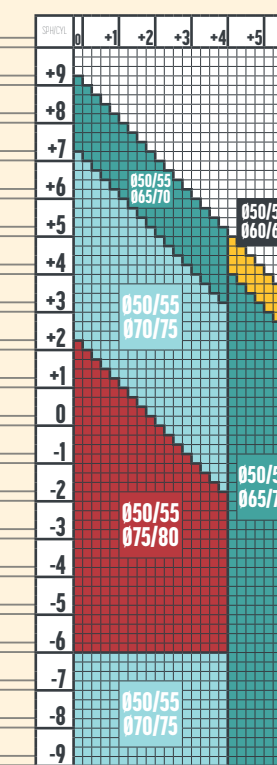
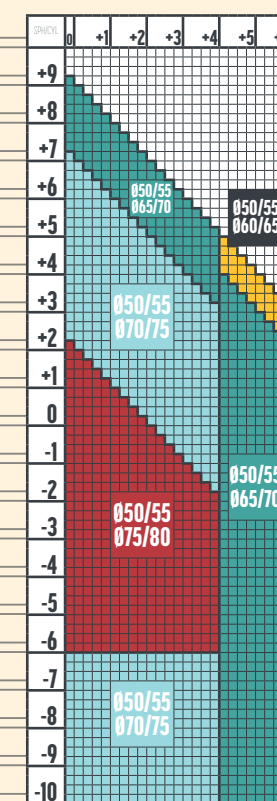
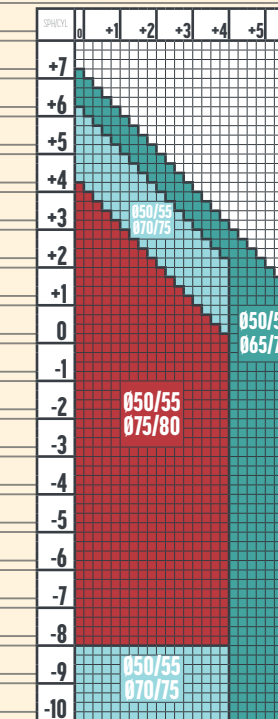
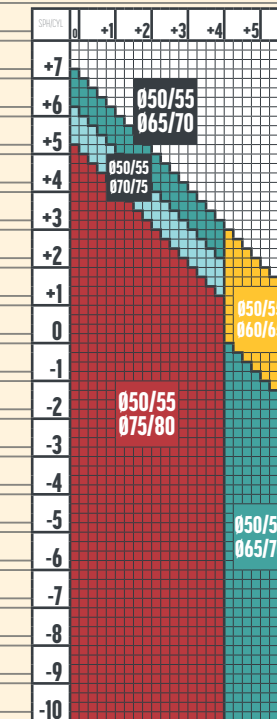
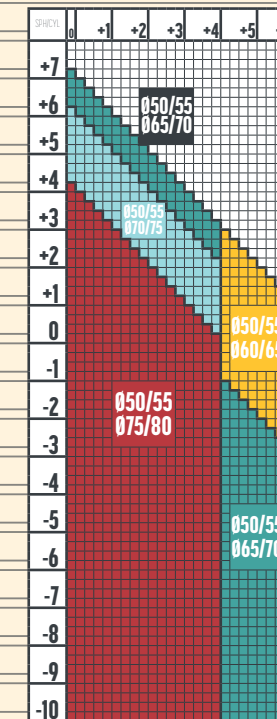
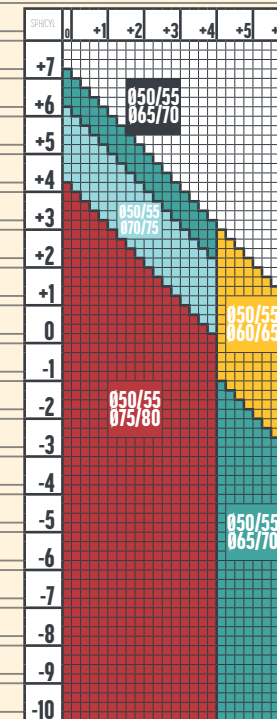
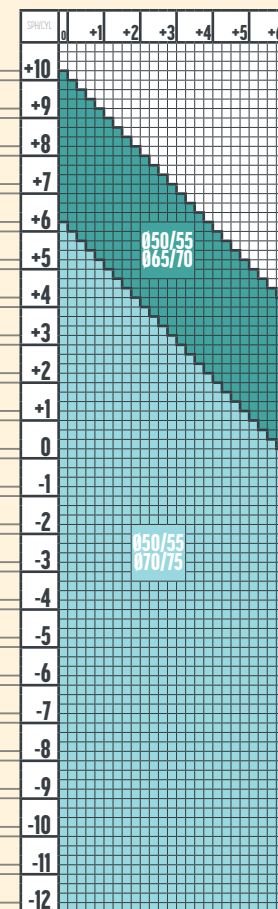
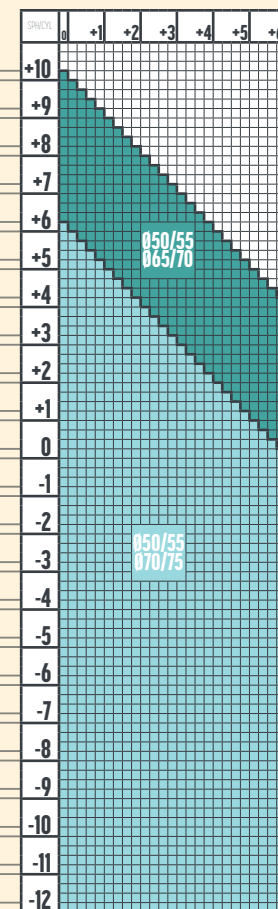
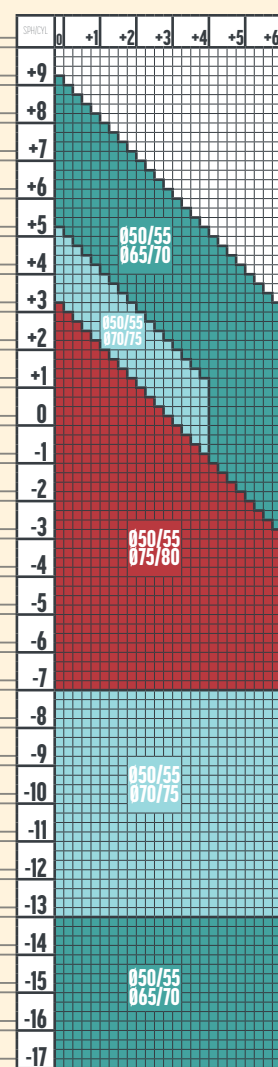

Adiție 0.75 - 3.50 / 0.25

Adiție 0.75 - 3.50 / 0.25

Adiție 0.75 - 3.50 / 0.25

Adiție 0.75 - 3.50 / 0.25

Adiție 0.75 - 3.50 / 0.25

Adiție 0.75 - 3.50 / 0.25

Adiție 0.75 - 3.50 / 0.25

Adiție 0.75 - 3.50 / 0.25

Adiție 0.75 - 3.50 / 0.25

Colorare	NU	NU	NU	NU	NU	NU	NU	NU	NU
Tratamente disponibile	ULTRA BLUE / ULTRA / HYDRO+ / HMC / HC	ULTRA BLUE / ULTRA / HYDRO+ / HMC / HC	ULTRA BLUE / ULTRA / HYDRO+ / HMC / HC	ULTRA BLUE / ULTRA / HYDRO+ / HMC / HC	ULTRA BLUE / ULTRA / HYDRO+ / HMC / HC	ULTRA BLUE / ULTRA / HYDRO+ / HMC / HC	ULTRA BLUE / ULTRA / HYDRO+ / HMC / HC	ULTRA BLUE / ULTRA / HYDRO+ / HMC / HC	ULTRA BLUE / ULTRA / HYDRO+ / HMC / HC
Tratamente adiționale	-	-	-	PURE	PURE	-	-	PURE	PURE

INNOVATOR DEGRESIV HOME, OFFICE, DESKTOP, COMPUTER
LENTILE TRANSPARENTE
INDICE: 1.74 / 1.67 / 1.6 / 1.59 / 1.53 / 1.5

LUNGIMI PROGRESIE INNOVATOR DEGRESIV	
Lungime progresie	Înălțime montaj min. / recomandată (mm)
M	18 / 20

LENTILE BIFOCAL

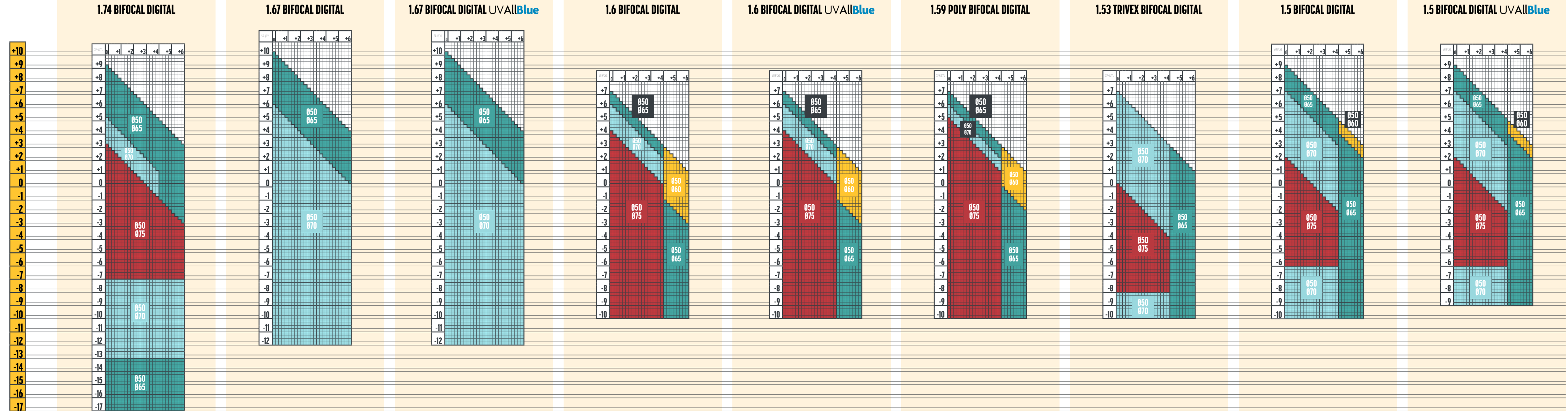

	1.74 BIFOCAL DIGITAL	1.67 BIFOCAL DIGITAL	1.67 BIFOCAL DIGITAL UVAIIBlue	1.6 BIFOCAL DIGITAL	1.6 BIFOCAL DIGITAL UVAIIBlue	1.59 POLY BIFOCAL DIGITAL	1.53 TRIVEX BIFOCAL DIGITAL	1.5 BIFOCAL DIGITAL	1.5 BIFOCAL DIGITAL UVAIIBlue
Adiție 0.50 - 4.00 / 0.25	Adiție 0.50 - 4.00 / 0.25	Adiție 0.50 - 4.00 / 0.25	Adiție 0.50 - 4.00 / 0.25	Adiție 0.50 - 4.00 / 0.25	Adiție 0.50 - 4.00 / 0.25	Adiție 0.50 - 4.00 / 0.25	Adiție 0.50 - 4.00 / 0.25	Adiție 0.50 - 4.00 / 0.25	Adiție 0.50 - 4.00 / 0.25
Colorare	NU	DA	DA	DA	DA	NU	NU	DA	DA
Tratamente disponibile	ULTRA BLUE / ULTRA / HYDRO+ / HMC	ULTRA BLUE / ULTRA / HYDRO+ / HMC	ULTRA BLUE / ULTRA / HYDRO+ / HMC	ULTRA BLUE / ULTRA / HYDRO+ / HMC / HC	ULTRA BLUE / ULTRA / HYDRO+ / HMC / HC	ULTRA BLUE / ULTRA / HYDRO+ / HMC	ULTRA BLUE / ULTRA / HYDRO+ / HMC / HC	ULTRA BLUE / ULTRA / HYDRO+ / HMC / HC / UC	ULTRA BLUE / ULTRA / HYDRO+ / HMC / HC
Tratamente adiționale	-	COLOR / MIRROR solid/gradient max. 85%	COLOR / MIRROR solid/gradient max. 85%	COLOR / MIRROR / PURE solid/gradient max. 85%	COLOR / MIRROR / PURE solid/gradient max. 85%	-	-	COLOR / MIRROR / PURE / UV solid/gradient max. 85%	COLOR / MIRROR / PURE solid/gradient max. 85%

1.74 DIGITAL TINT

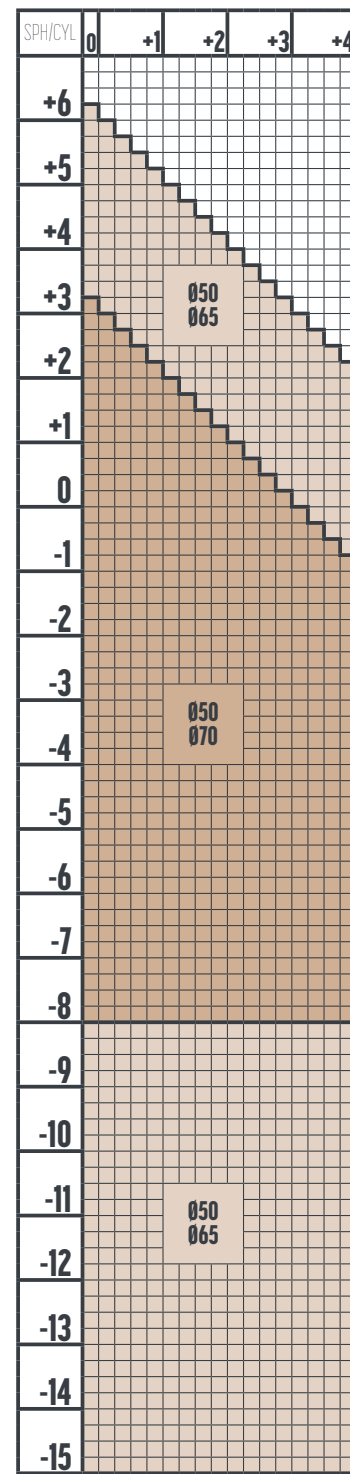

Tintable ranges according to the specific diameter.

BIFOCAL DIGITAL RS28 / RS40
LENILE TRANSPARENTE
INDICE: 1.74 / 1.67 / 1.6 / 1.59 / 1.53 / 1.5

	1.74 BIFOCAL TRANSITIONS	1.67 BIFOCAL TRANSITIONS 1.67 BIFOCAL TRANSITIONS XTRACTIVE	1.6 BIFOCAL TRANSITIONS 1.6 BIFOCAL TRANSITIONS XTRACTIVE	1.59 POLY BIFOCAL TRANSITIONS XTRACTIVE	1.59 POLY BIFOCAL TRANSITIONS	1.56 BIFOCAL PHOTO	1.53 TRIVEX BIFOCAL TRANSITIONS XTRACTIVE	1.53 TRIVEX BIFOCAL TRANSITIONS	1.5 BIFOCAL TRANSITIONS 1.5 BIFOCAL TRANSITIONS XTRACTIVE
	COLORI TRANSITIONS Adiție 0.50 - 4.00 / 0.25	COLORI TRANSITIONS XTRACTIVE COLORI TRANSITIONS Adiție 0.50 - 4.00 / 0.25	COLORI TRANSITIONS XTRACTIVE COLORI TRANSITIONS Adiție 0.50 - 4.00 / 0.25	COLORI TRANSITIONS XTRACTIVE Adiție 0.50 - 4.00 / 0.25	COLORI TRANSITIONS Adiție 0.50 - 4.00 / 0.25	COLORI PHOTO Adiție 0.50 - 4.00 / 0.25	COLORI TRANSITIONS XTRACTIVE Adiție 0.50 - 4.00 / 0.25	COLORI TRANSITIONS Adiție 0.50 - 4.00 / 0.25	COLORI TRANSITIONS XTRACTIVE COLORI TRANSITIONS Adiție 0.50 - 4.00 / 0.25
Colorare	NU	NU	NU	NU	NU	NU	NU	NU	NU
Tratamente disponibile	ULTRA BLUE / ULTRA / HYDRO+ / HMC	ULTRA BLUE / ULTRA / HYDRO+ / HMC	ULTRA BLUE / ULTRA / HYDRO+ / HMC / HC	ULTRA BLUE / ULTRA / HYDRO+ / HMC / HC	ULTRA BLUE / ULTRA / HYDRO+ / HMC / HC	ULTRA BLUE / ULTRA / HYDRO+ / HMC / HC	ULTRA BLUE / ULTRA / HYDRO+ / HMC / HC	ULTRA BLUE / ULTRA / HYDRO+ / HMC / HC	ULTRA BLUE / ULTRA / HYDRO+ / HMC / HC
Tratamente adiționale	-	-	PURE	-	-	-	-	-	PURE

BIFOCAL DIGITAL RS28 / RS40
LENTILE FOTOCROMATICE
INDICE: 1.74 / 1.67 / 1.6 / 1.59 / 1.56 / 1.53 / 1.5

1.67 BIFOCAL DIGITAL NUPOLAR

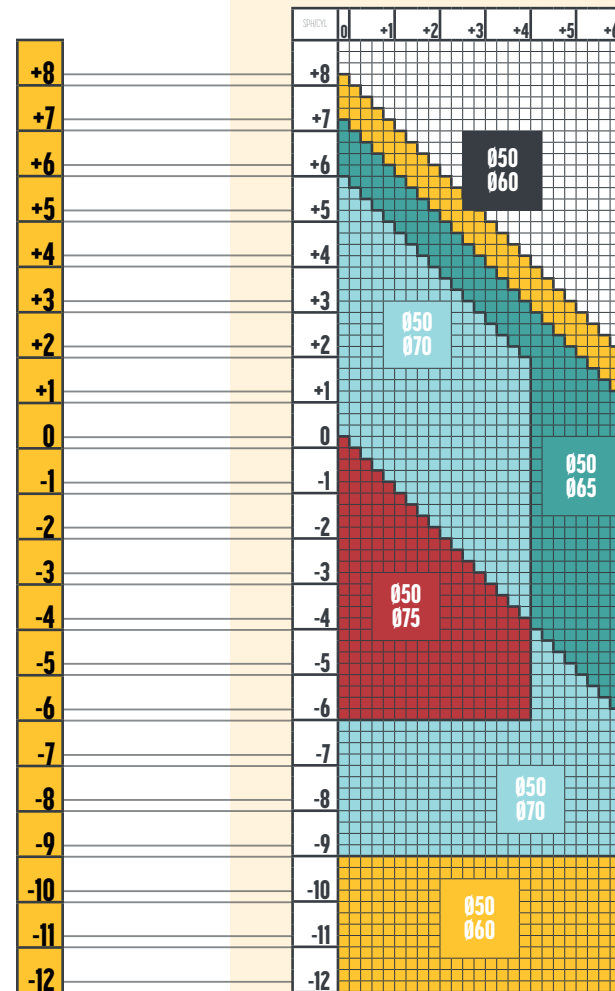

CULORI NUPOLAR



VERDE G15 GR13 MARO
Adiție 0.50 - 4.00 / 0.25

1.6 BIFOCAL DIGITAL NUPOLAR

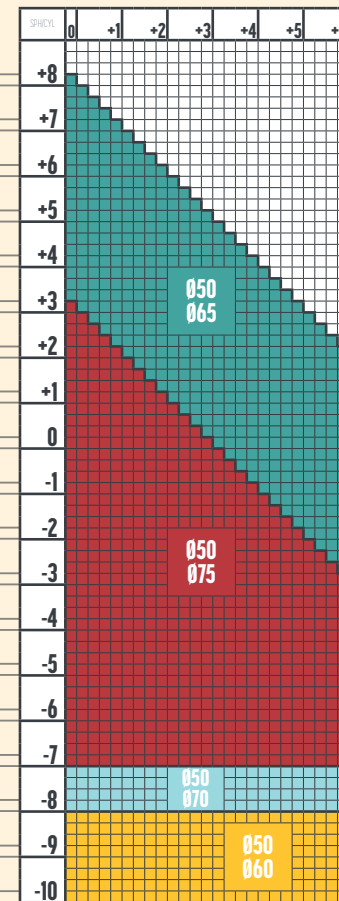

CULORI NUPOLAR



VERDE G15 GR13 MARO
Adiție 0.50 - 4.00 / 0.25

1.59 POLYBIFOCAL DIGITAL TRANSITIONS DRIVEWEAR

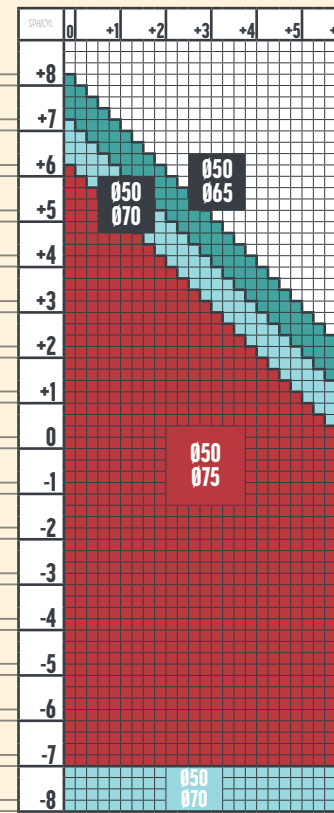

1.59 POLY BIFOCAL DIGITAL NUPOLAR

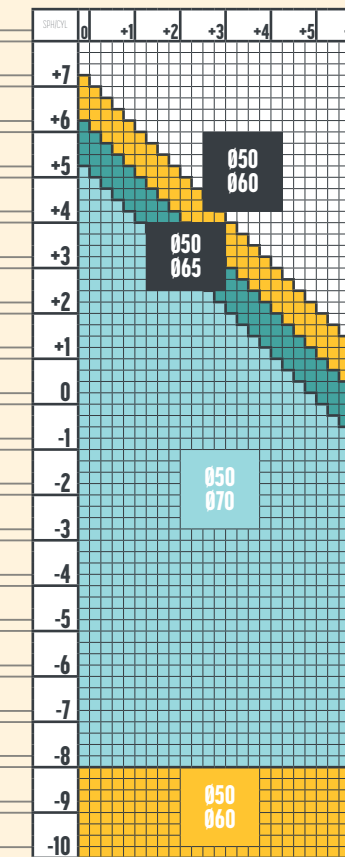

CULORI NUPOLAR

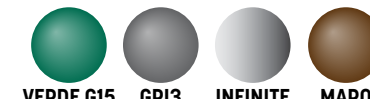

VERDE G15 GR13 INFINITE GREY MARO
Adiție 0.50 - 4.00 / 0.25

1.53 TRIVEX BIFOCAL DIGITAL NUPOLAR

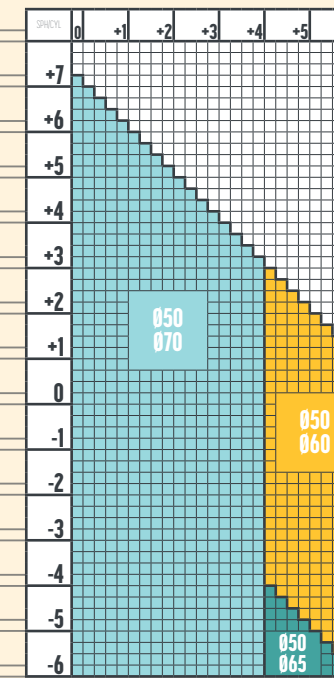

CULORI NUPOLAR



GR13 MARO
Adiție 0.50 - 4.00 / 0.25

1.5 BIFOCAL DIGITAL TRANSITIONS DRIVEWEAR

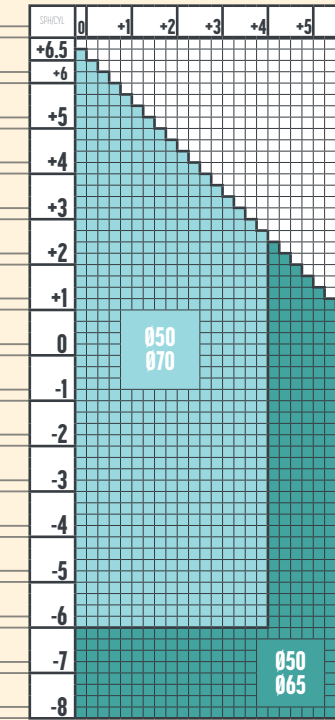

Adiție 0.50 - 4.00 / 0.25

1.5 BIFOCAL DIGITAL NUPOLAR

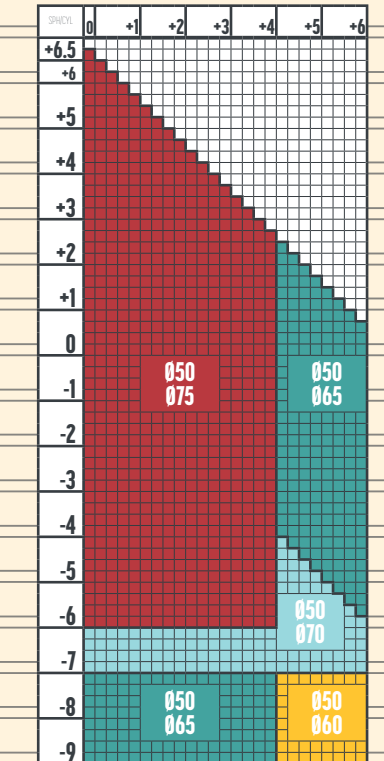

CULORI NUPOLAR

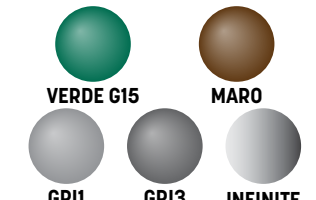

VERDE G15 MARO
GR11 GR13 INFINITE GREY
Adiție 0.50 - 4.00 / 0.25

Colorare	NU	NU	NU	NU	NU	NU	NU
Tratamente disponibile	ULTRA / HYDRO+ / HMC	ULTRA / HYDRO+ / HMC	ULTRA / HYDRO+ / HMC / HC	ULTRA / HYDRO+ / HMC / HC	ULTRA / HYDRO+ / HMC / HC	ULTRA / HYDRO+ / HMC / HC	ULTRA / HYDRO+ / HMC / HC
Tratamente adiționale	-	PURE	-	-	-	PURE	PURE

BIFOCAL DIGITAL RS28 / RS40
LENILE POLARIZANTE
INDICE: 1.67 / 1.6 / 1.59 / 1.53 / 1.5

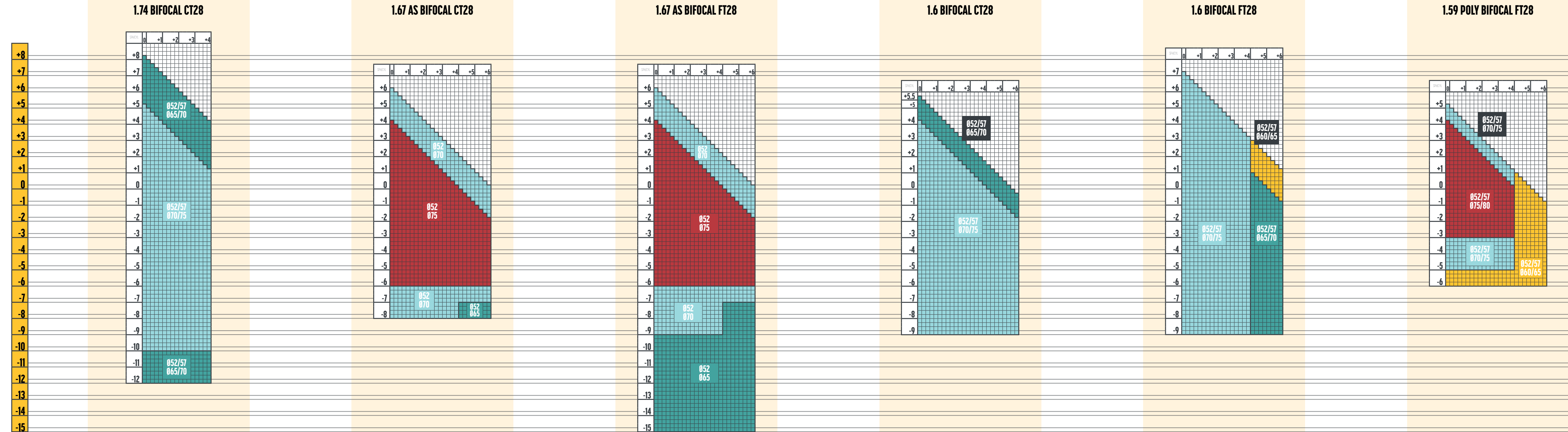

	1.74 BIFOCAL CT28	1.67 AS BIFOCAL CT28	1.67 AS BIFOCAL FT28	1.6 BIFOCAL CT28	1.6 BIFOCAL FT28	1.59 POLY BIFOCAL FT28
Adiție	1.00 - 3.00	1.00 - 3.00	1.00 - 3.00	0.75 - 3.50	1.00 - 3.00	1.00 - 3.00
Colorare	NU	DA	DA	DA	DA	NU
Tratamente disponibile	ULTRA BLUE / ULTRA / HYDRO+ / HMC	ULTRA BLUE / ULTRA / HYDRO+ / HMC / HC	ULTRA BLUE / ULTRA / HYDRO+ / HMC / HC	ULTRA BLUE / ULTRA / HYDRO+ / HMC / HC	ULTRA BLUE / ULTRA / HYDRO+ / HMC / HC	ULTRA BLUE / ULTRA / HYDRO+ / HMC / HC
Tratamente adiționale	-	COLOR solid/gradient max. 85%	COLOR solid/gradient max. 85%	COLOR / MIRROR / PURE solid/gradient max. 85%	COLOR / MIRROR / PURE solid/gradient max. 85%	-

BIFOCAL CT28, FT28
LENTILE TRANSPARENTE
INDICE: 1.74 / 1.67 AS / 1.6 / 1.59

BIFOCAL FT28, CT28, RS24, FT35, FT45, E-LINE
LENTILE TRANSPARENTE
INDICE: 1.5

1.56 BIFOCAL FT28 PHOTO

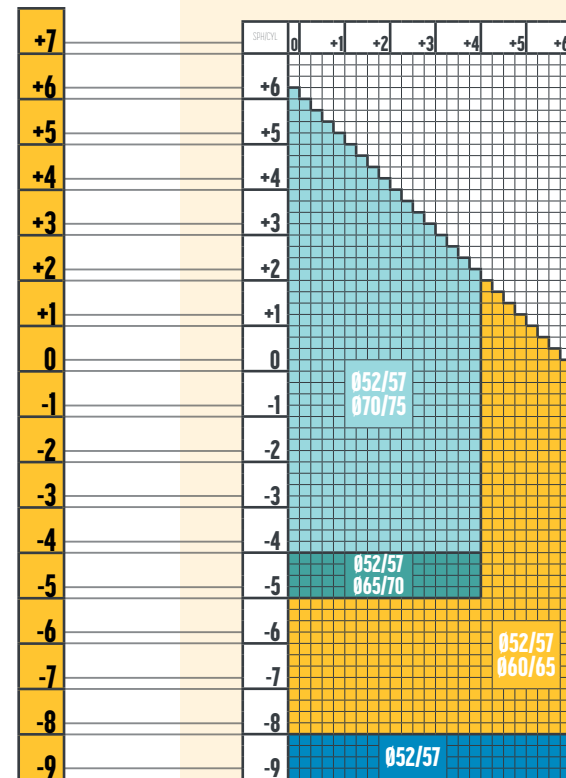

1.53 TRIVEX BIFOCAL FT28 TRANSITIONS

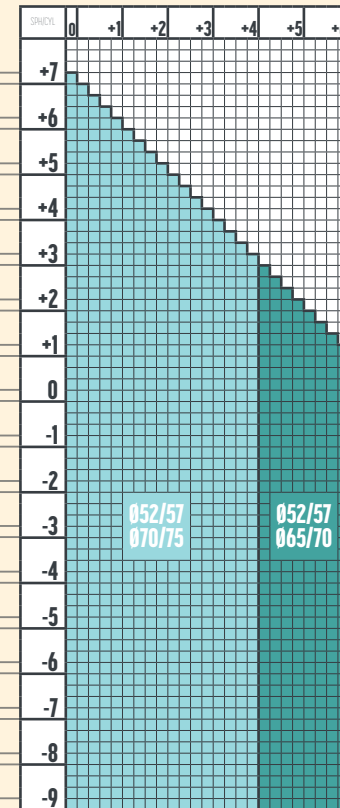

1.5 BIFOCAL FT28 TRANSITIONS

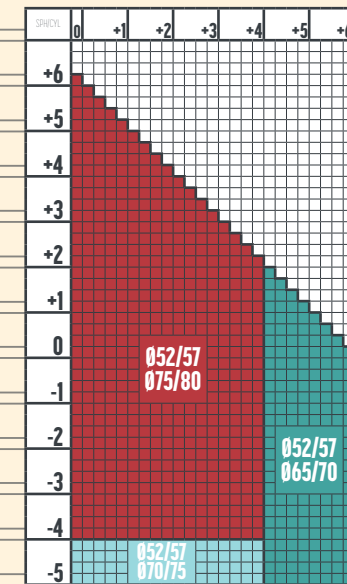

1.5 BIFOCAL CT28 TRANSITIONS

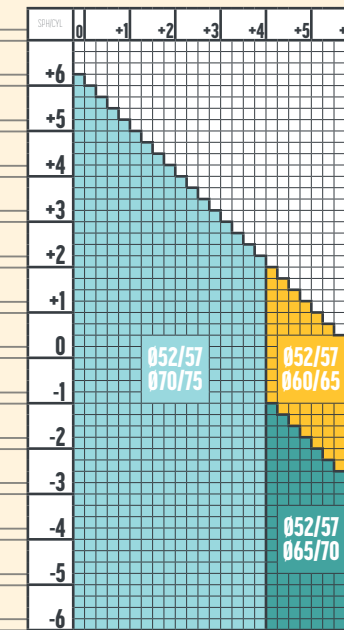

1.5 BIFOCAL FT28 DRIVEWEAR

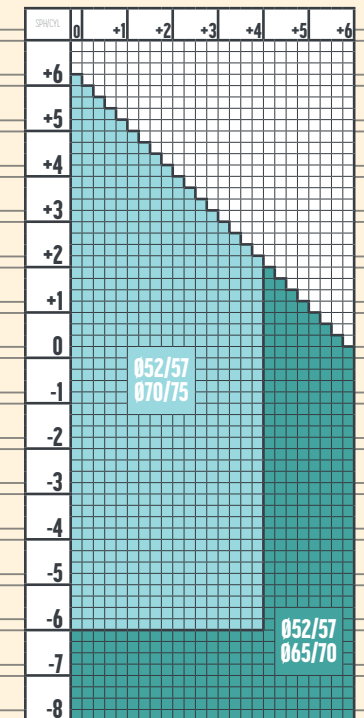

CULORI PHOTO



Adiție 1.00 - 3.00

CULORI TRANSITIONS



Adiție 1.00 - 3.50

CULORI TRANSITIONS



Adiție 1.00 - 3.00

CULORI TRANSITIONS



Adiție 1.00 - 3.50

Adiție 1.00 - 3.00

Colorare	NU	NU	NU	NU	NU
Tratamente disponibile	ULTRA BLUE / ULTRA / HYDRO+ / HMC / HC	ULTRA BLUE / ULTRA / HYDRO+ / HMC / HC	ULTRA BLUE / ULTRA / HYDRO+ / HMC / HC	ULTRA BLUE / ULTRA / HYDRO+ / HMC / HC	ULTRA / HYDRO+ / HMC / HC
Tratamente adiționale	-	-	PURE	PURE	PURE

BIFOCAL FT28, CT28
LENTILE FOTOCROMATICE
INDICE: 1.56 / 1.53 / 1.5

BIFOCAL FT28
LENTILE POLARIZANTE
INDICE: 1.5

BIFOCAL MINERAL FT28 - LENTILE TRANSPARENTE, FOTOCROMATICE - INDICE: 1.5

1.5 BIFOCAL MINERAL FT28

1.5 BIFOCAL MINERAL FT28 PHOTO

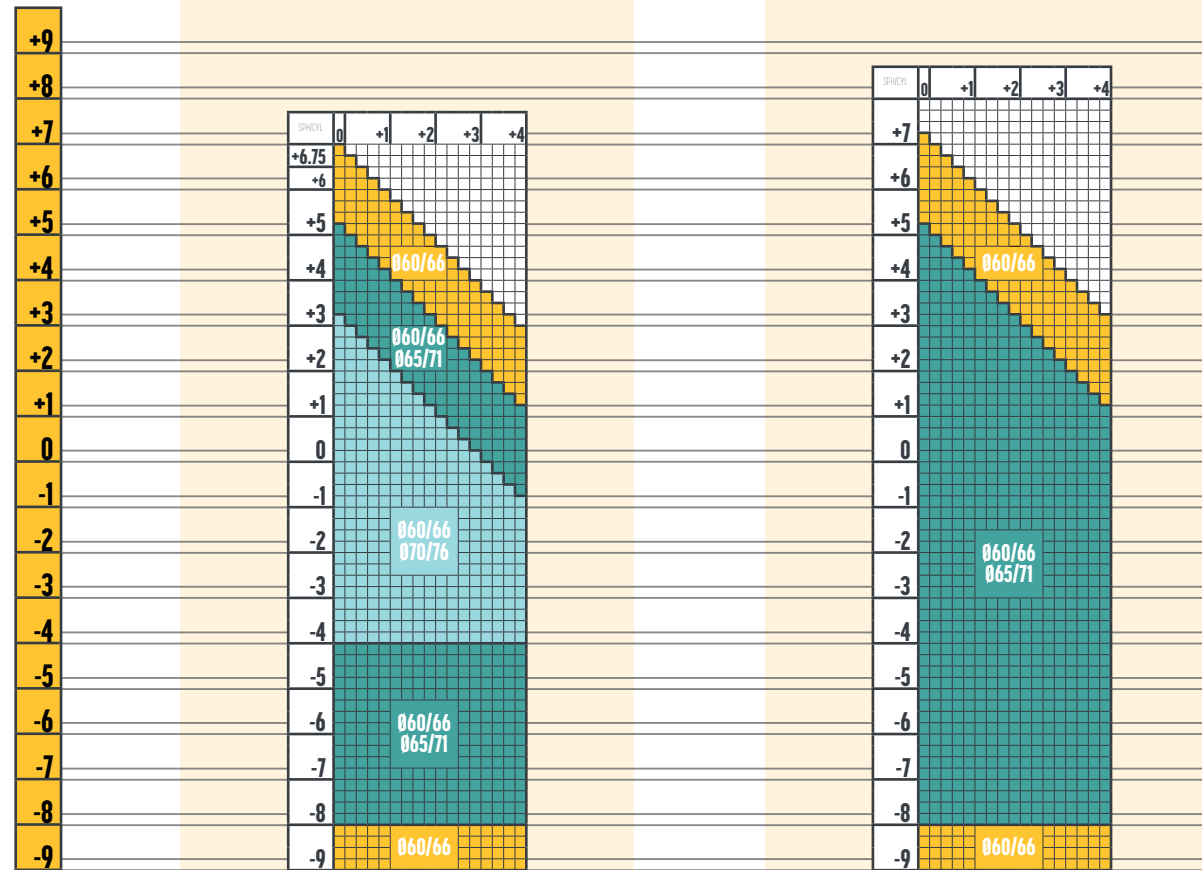

CULORI PHOTO



Adiție 1.00 - 4.00

Adiție 1.00 - 3.00

Colorare	DA	NU
Tratamente disponibile	ULTRA / HYDRO+ / AR (disponibil și UC)	ULTRA / HYDRO+ / AR (disponibil și UC)
Tratamente adiționale	-	-

Colorare disponibilă

Culoare	Procentaj colorare
GRI SOLID	25%
GRI SOLID	50%
GRI SOLID	75%
MARO SOLID / GRADIENT	15%
MARO SOLID / GRADIENT	25%
MARO SOLID / GRADIENT	50%
MARO SOLID / GRADIENT	75%

BIFOCAL MINERAL FT28

LENTILE TRANSPARENTE

INDICE: 1.5

BIFOCAL MINERAL FT28

LENTILE FOTOCROMATICE

INDICE: 1.5

LENTILE MONOFOCALE

MONOFOCAL ORGANIC INDIVIDUAL, ORGANIC PLUS, ORGANIC - LENTILE TRANSPARENTE - INDICE 1.74 AS / 1.74 / 1.67 AS / 1.67; MONOFOCAL ORGANIC INDIVIDUAL UVAllBlue, ORGANIC PLUS UVAllBlue, ORGANIC UVAllBlue - LENTILE TRANSPARENTE - INDICE 1.67 AS / 1.67

1.74 AS ORGANIC
1.74 ORGANIC

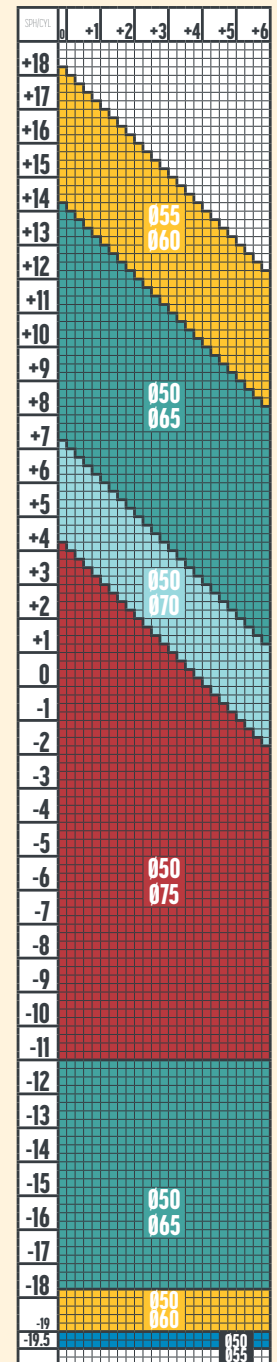

1.74 AS ORGANIC TINT*
1.74 ORGANIC INDIVIDUAL TINT
1.74 ORGANIC PLUS TINT
1.74 ORGANIC TINT*

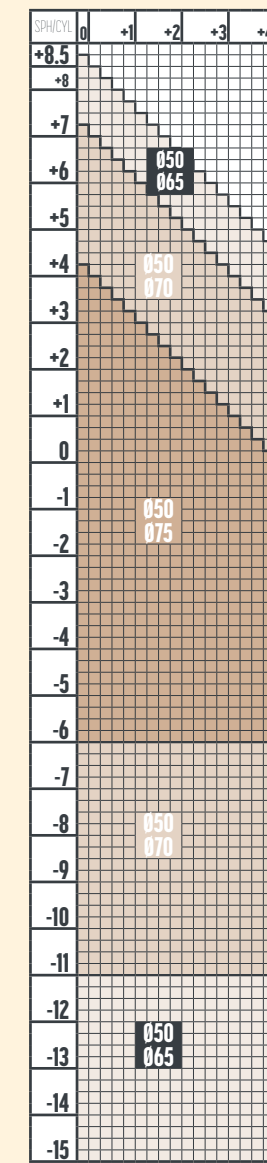

Dioptrii care se pot colora, conform diametrelor.
*1.74 AS ORGANIC și 1.74 ORGANIC nu este disponibil cu tratamentele ARUS și ARUS BLUE

1.74 ORGANIC INDIVIDUAL
1.74 ORGANIC PLUS

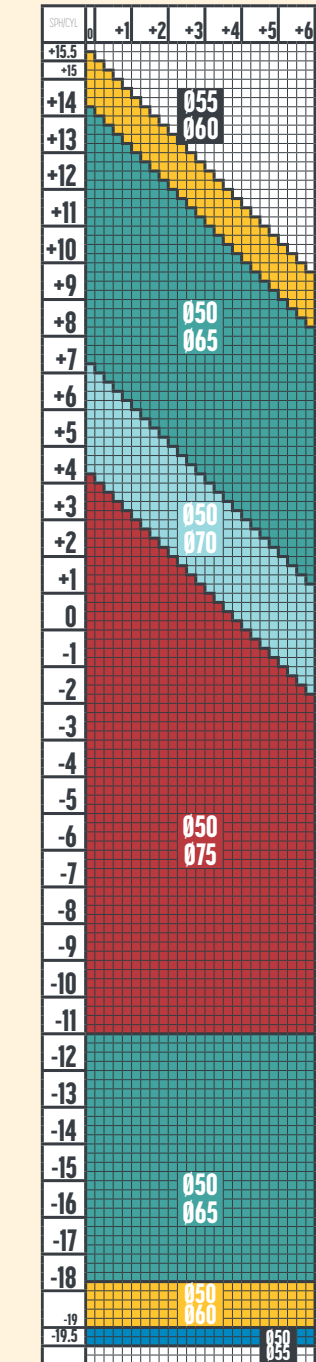

1.67 AS ORGANIC
1.67 ORGANIC

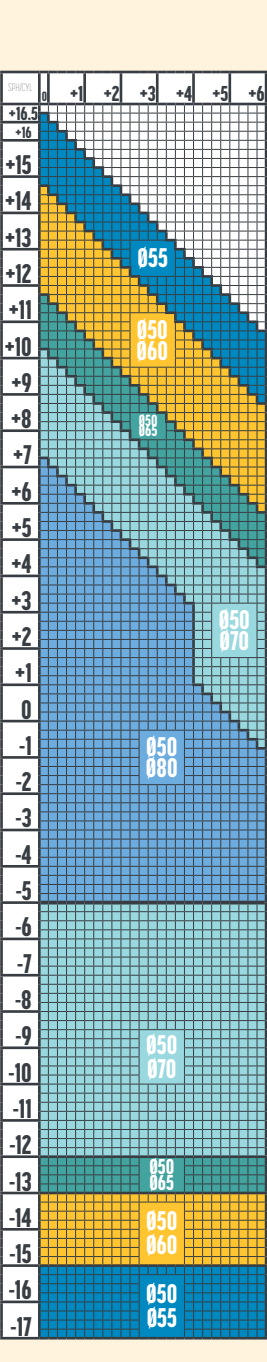

1.67 ORGANIC INDIVIDUAL
1.67 ORGANIC PLUS

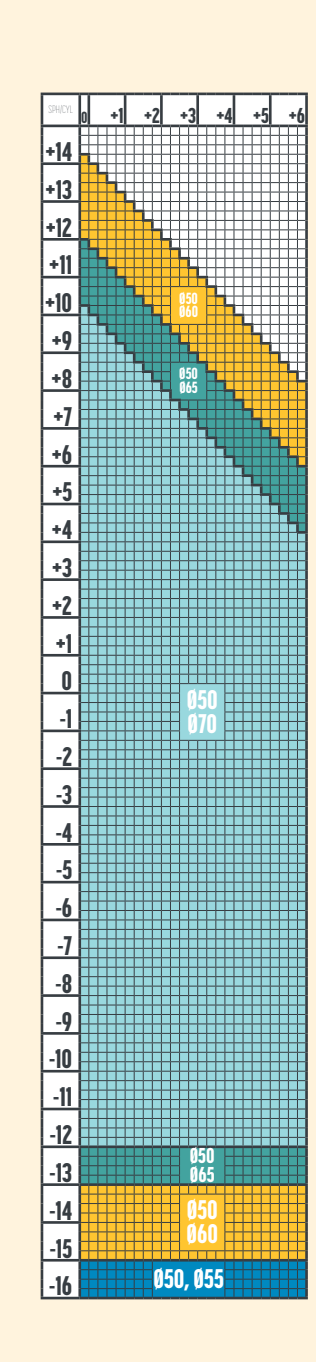

1.67 AS ORGANIC UVAllBlue
1.67 ORGANIC UVAllBlue

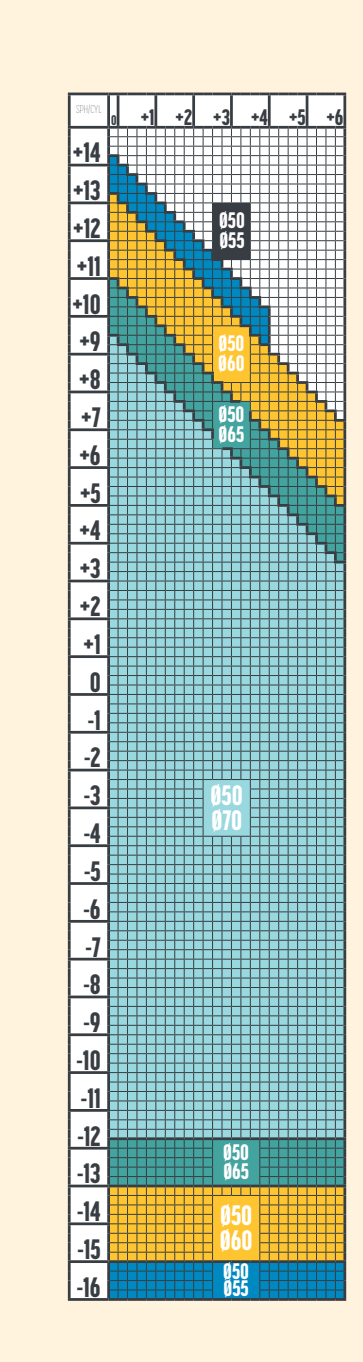

1.67 ORGANIC INDIVIDUAL UVAllBlue
1.67 ORGANIC PLUS UVAllBlue

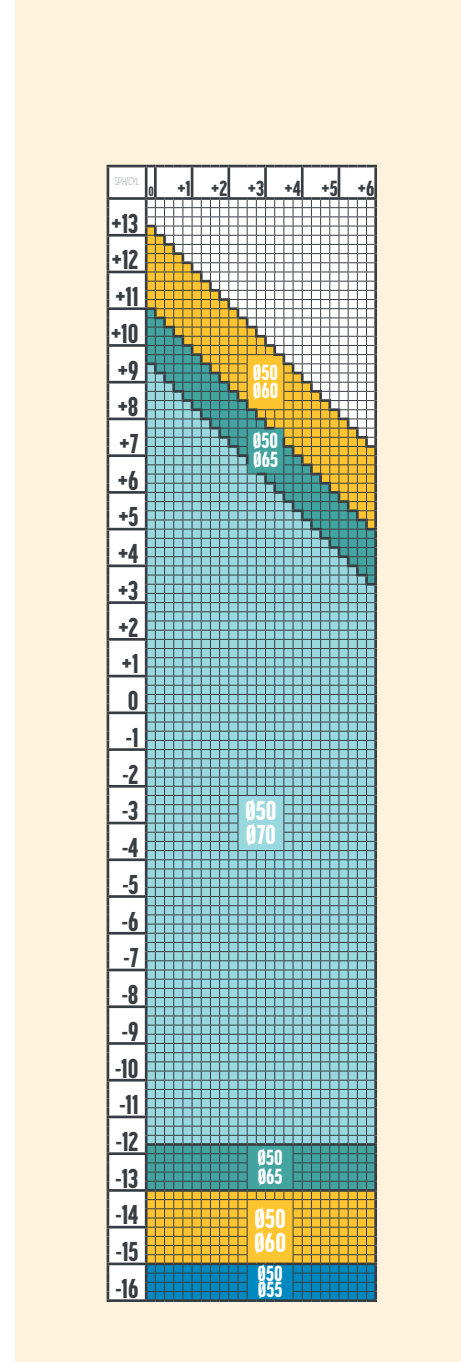

Colorare	NU	DA	NU	DA	DA	DA	DA
Tratamente disponibile	ULTRA BLUE / ULTRA / HYDRO+ / HMC	ARUS BLUE / ARUS / ULTRA BLUE / ULTRA / HYDRO+ / HMC	ARUS BLUE / ARUS / ULTRA BLUE / ULTRA / HYDRO+ / HMC	ULTRA BLUE / ULTRA / HYDRO+ / HMC	ARUS BLUE / ARUS / ULTRA BLUE / ULTRA / HYDRO+ / HMC	ULTRA BLUE / ULTRA / HYDRO+ / HMC	ARUS BLUE / ARUS / ULTRA BLUE / ULTRA / HYDRO+ / HMC
Tratamente aditionale	-	COLOR / MIRROR solid/gradient max. 85%	-	COLOR / MIRROR solid/gradient max. 85%	COLOR / MIRROR solid/gradient max. 85%	COLOR / MIRROR solid/gradient max. 85%	COLOR / MIRROR solid/gradient max. 85%

**MONOFOCAL ORGANIC INDIVIDUAL, ORGANIC PLUS, ORGANIC,
LENTILE TRANSPARENTE
INDICE: 1.74 AS / 1.74 / 1.67 AS / 1.67**

***Tratamentele ARUS BLUE și ARUS sunt disponibile doar pentru produsele ORGANIC INDIVIDUAL și ORGANIC PLUS.**

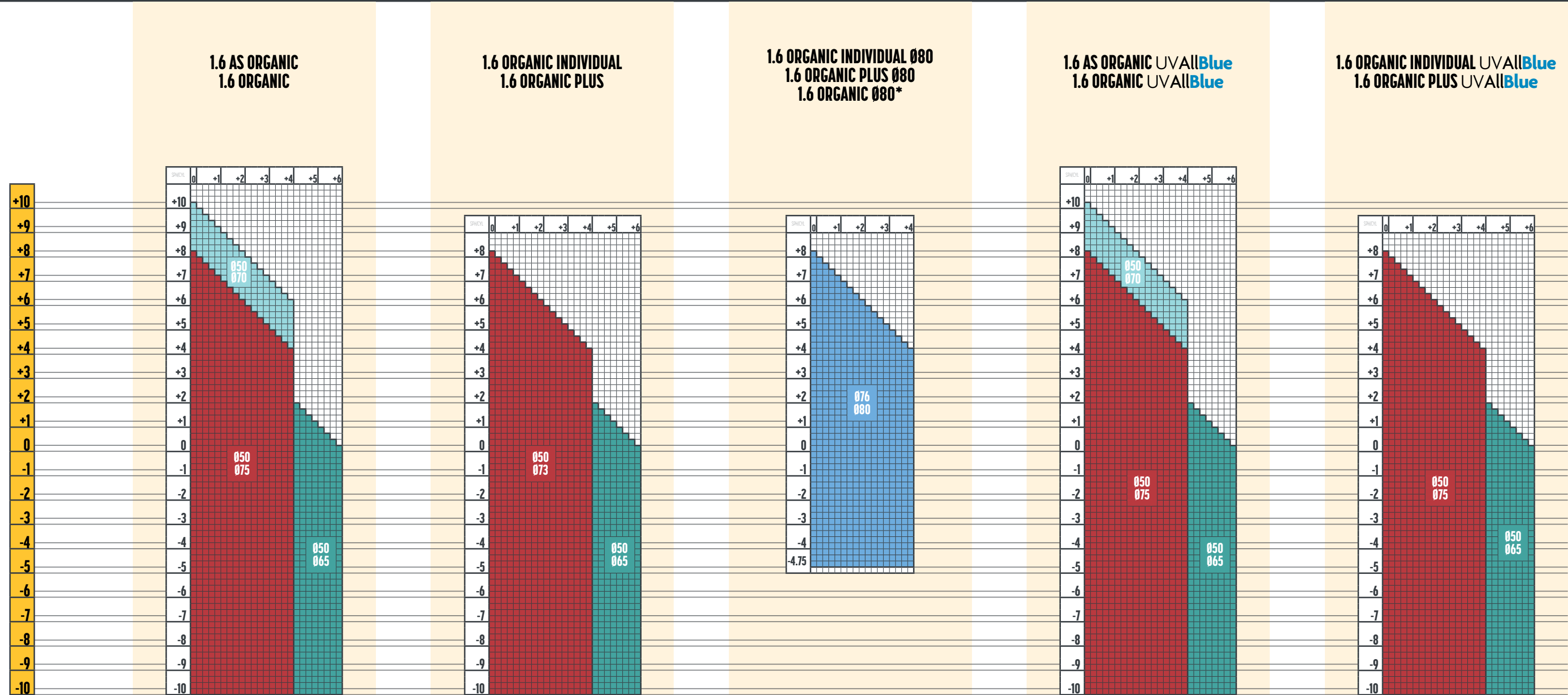

*1.6 ORGANIC Ø80 nu este disponibil cu tratamentele ARUS și ARUS BLUE

Colorare	DA	DA	DA	DA	DA
Tratamente disponibile	ULTRA BLUE / ULTRA / HYDRO+ / HMC / HC	ARUS BLUE / ARUS / ULTRA BLUE / ULTRA / HYDRO+ / HMC / HC	ARUS BLUE / ARUS / ULTRA BLUE / ULTRA / HYDRO+ / HMC / HC	ULTRA BLUE / ULTRA / HYDRO+ / HMC / HC	ARUS BLUE / ARUS / ULTRA BLUE / ULTRA / HYDRO+ / HMC / HC
Tratamente adiționale	COLOR / MIRROR / PURE solid/gradient max. 85%	COLOR / MIRROR / PURE solid/gradient max. 85%	COLOR / MIRROR / PURE solid/gradient max. 85%	COLOR / MIRROR / PURE solid/gradient max. 85%	COLOR / MIRROR / PURE solid/gradient max. 85%

MONOFOCAL ORGANIC INDIVIDUAL, ORGANIC PLUS, ORGANIC
LENTILE TRANSPARENTE
INDICE: 1.6 AS / 1.6 / 1.6 Ø80

***Tratamentele ARUS BLUE și ARUS sunt disponibile doar pentru produsele ORGANIC INDIVIDUAL și ORGANIC PLUS.**

MONOFOCAL ORGANIC INDIVIDUAL, ORGANIC PLUS, ORGANIC - LENTILE TRANSPARENTE - INDICE 1.59 AS / 1.59 / 1.56 AS / 1.56 / 1.53 AS / 1.53

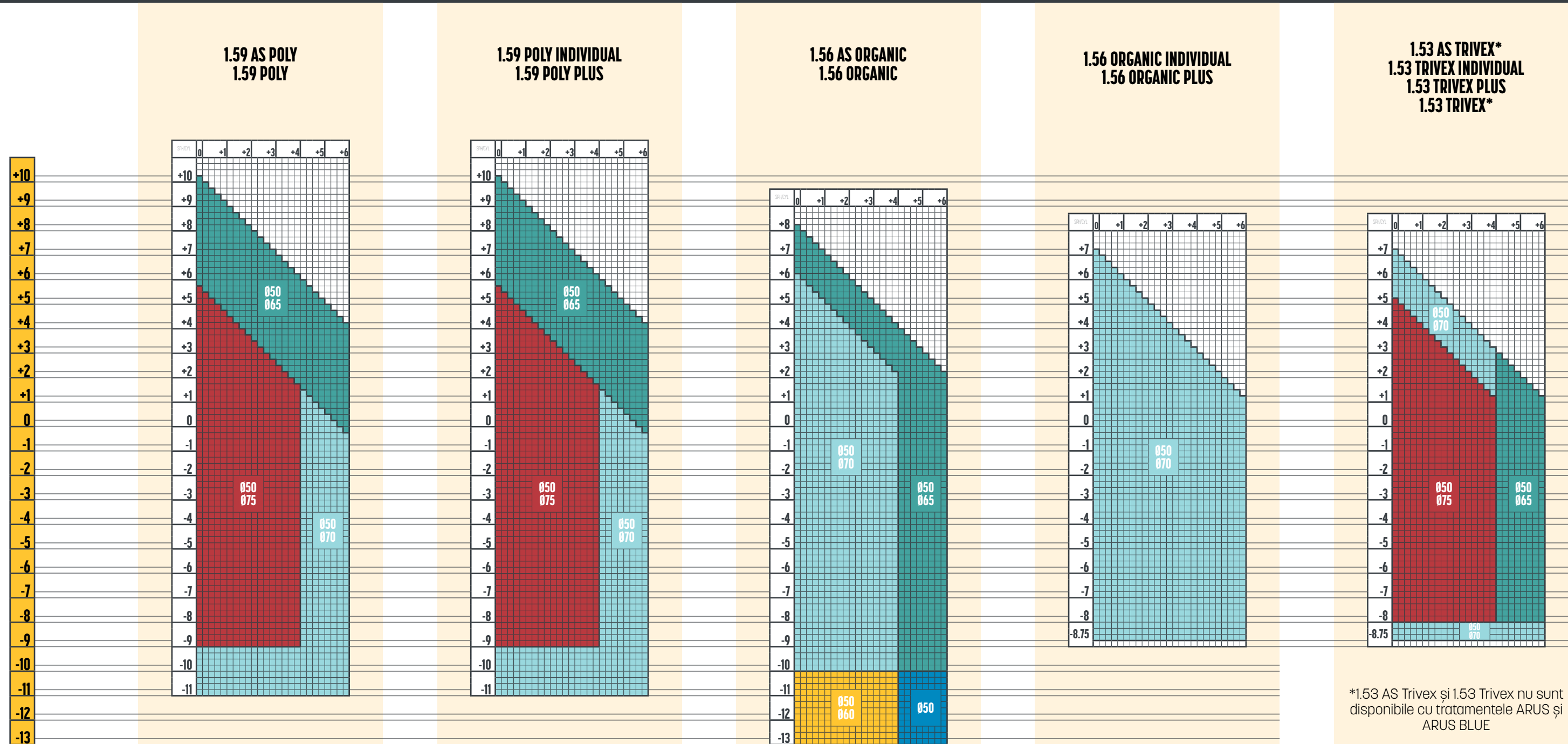

*1.53 AS Trivex și 1.53 Trivex nu sunt disponibile cu tratamentele ARUS și ARUS BLUE

Colorare	NU	NU	DA	DA	NU
Tratamente disponibile	ULTRA BLUE / ULTRA / HYDRO+ / HMC / HC	ARUS BLUE / ARUS / ULTRA BLUE / ULTRA / HYDRO+ / HMC / HC	ULTRA BLUE / ULTRA / HYDRO+ / HMC / HC	ARUS BLUE / ARUS / ULTRA BLUE / ULTRA / HYDRO+ / HMC / HC	ARUS BLUE / ARUS / ULTRA BLUE / ULTRA / HYDRO+ / HMC / HC
Tratamente adiționale	-	-	COLOR / MIRROR solid/gradient max. 75%	COLOR / MIRROR solid/gradient max. 75%	-

**MONOFOCAL ORGANIC INDIVIDUAL,
ORGANIC PLUS, ORGANIC
LENTILE TRANSPARENTE**

INDICE: 1.59 AS / 1.59 / 1.56 AS / 1.56 / 1.53 AS / 1.53

***Tratamentele ARUS BLUE și ARUS sunt disponibile doar pentru produsele ORGANIC INDIVIDUAL și ORGANIC PLUS.**

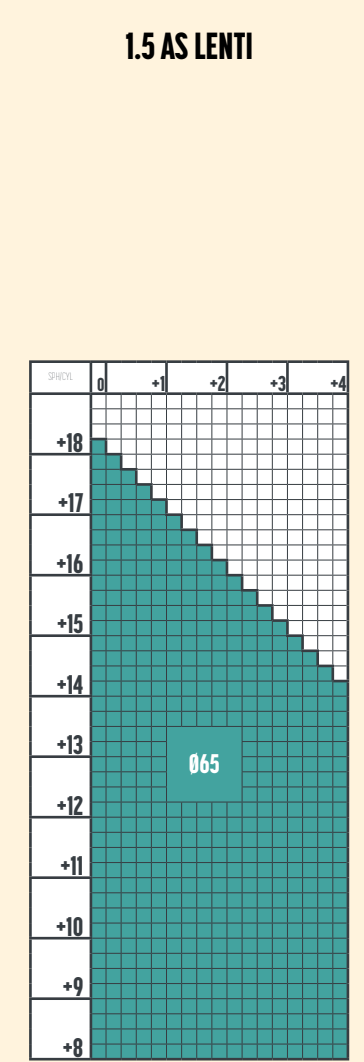
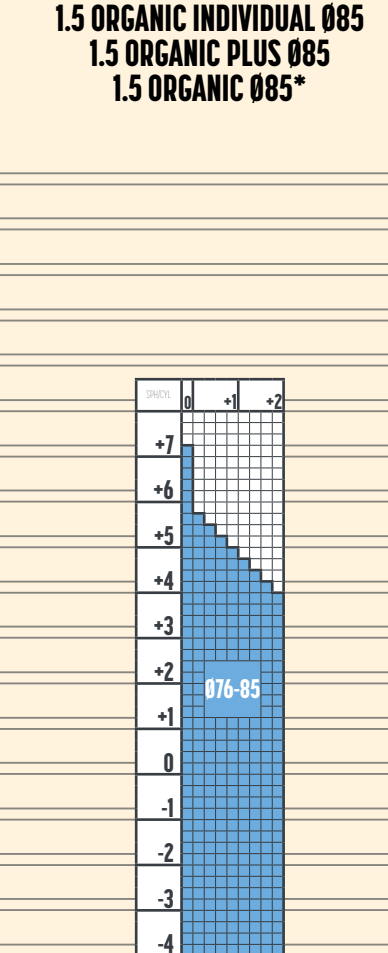
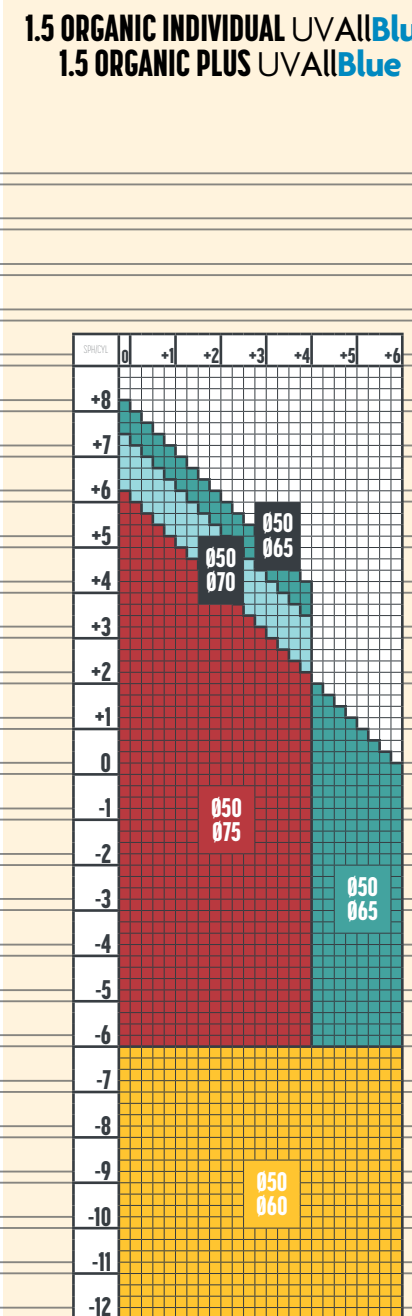
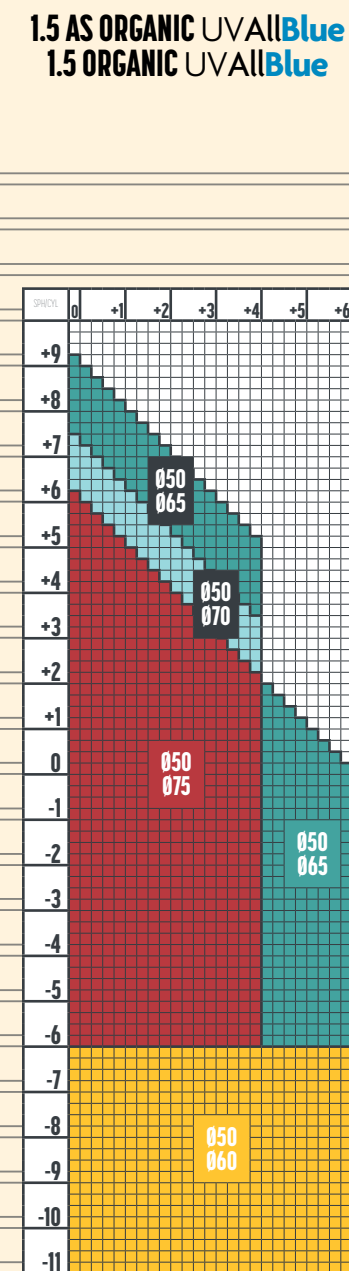
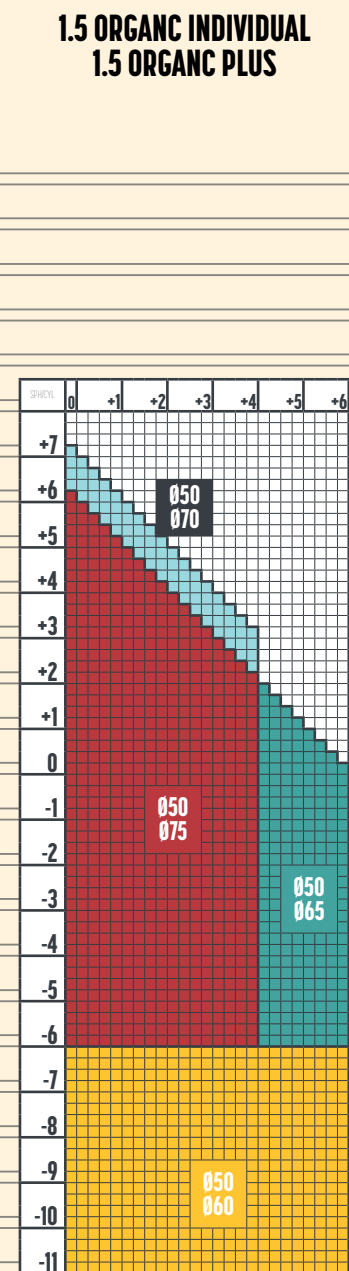
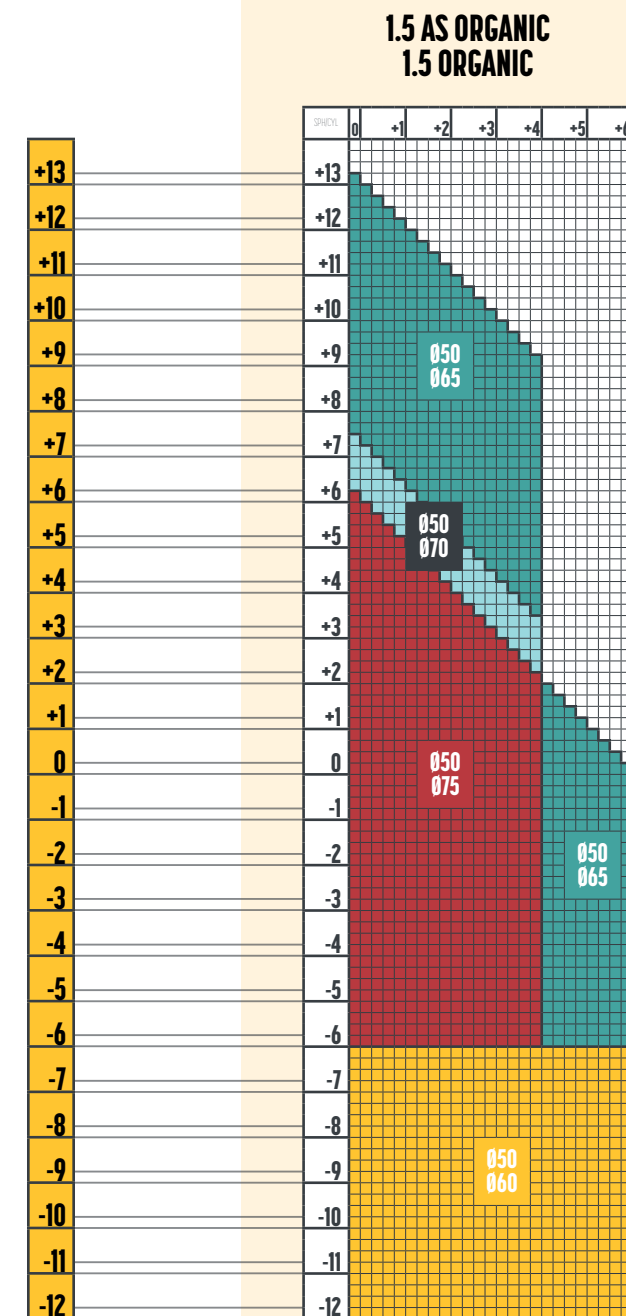

Dimensiunea lenticulului este de 35 mm

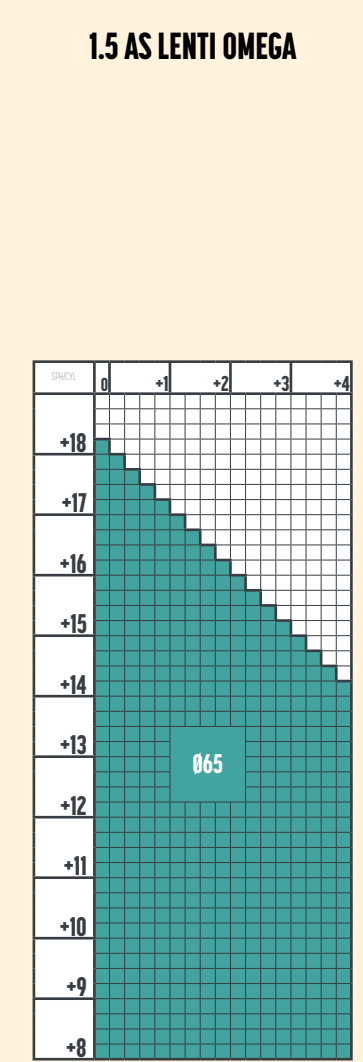

Dimensiunea lenticulului este de 43 mm

*1.5 ORGANIC Ø85 nu este disponibil cu tratamentele ARUS și ARUS BLUE

Colorare	DA	DA	DA	DA	DA	DA	DA
Tratamente disponibile	ULTRA BLUE / ARUS / HYDRO+ / HMC / HC / UC	ARUS BLUE / ARUS / ULTRA BLUE / ULTRA / HYDRO+ / HMC / HC / UC	ULTRA BLUE / ULTRA / HYDRO+ / HMC / HC	ARUS BLUE / ARUS / ULTRA BLUE / ULTRA / HYDRO+ / HMC / HC	ARUS BLUE / ARUS / ULTRA BLUE / ULTRA / HYDRO+ / HMC / HC	ULTRA BLUE / ULTRA / HYDRO+ / HMC / HC / UC	ULTRA BLUE / ULTRA / HYDRO+ / HMC / HC / UC
Tratamente adiționale	COLOR / MIRROR / PURE / UV solid/gradient max. 85%	COLOR / MIRROR / PURE / UV solid/gradient max. 85%	COLOR / MIRROR / PURE solid/gradient max. 85%	COLOR / MIRROR / PURE solid/gradient max. 85%	COLOR / MIRROR / PURE / UV solid/gradient max. 85%	COLOR / MIRROR / PURE / UV solid/gradient max. 85%	COLOR / MIRROR / PURE / UV solid/gradient max. 85%

MONOFOCAL ORGANIC INDIVIDUAL, ORGANIC PLUS, ORGANIC
LENTILE TRANSPARENTE
INDICE: 1.5 AS / 1.5 / 1.5 Ø85

***Tratamentele ARUS BLUE și ARUS sunt disponibile doar pentru produsele ORGANIC INDIVIDUAL și ORGANIC PLUS.**

MONOFOCAL ORGANIC INDIVIDUAL, ORGANIC PLUS, ORGANIC - LENTILE FOTOCROMATICE - INDICE 1.74 / 1.67 / 1.6 / 1.59 / 1.56 / 1.53 / 1.5

+10
+9
+8
+7
+6
+5
+4
+3
+2
+1
0
-1
-2
-3
-4
-5
-6
-7
-8
-9
-10
-11
-12
-13

1.74 ORGANIC INDIVIDUAL
1.74 ORGANIC PLUS
1.74 ORGANIC*
TRANSITIONS

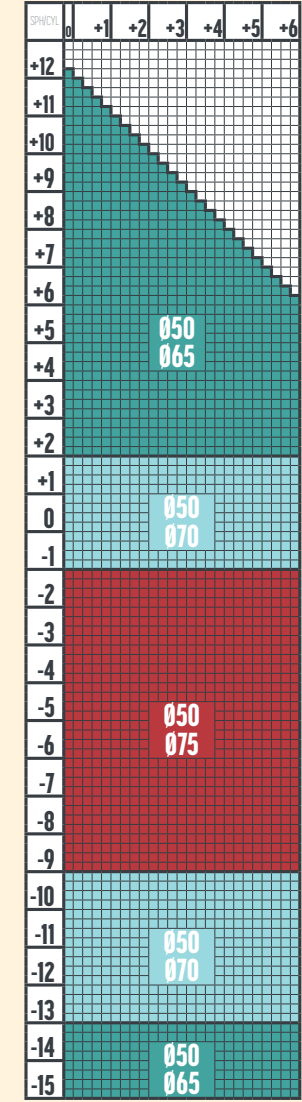

CULORI TRANSITIONS



1.67 ORGANIC INDIVIDUAL
1.67 ORGANIC PLUS
1.67 ORGANIC*
TRANSITIONS XTRACTIVE

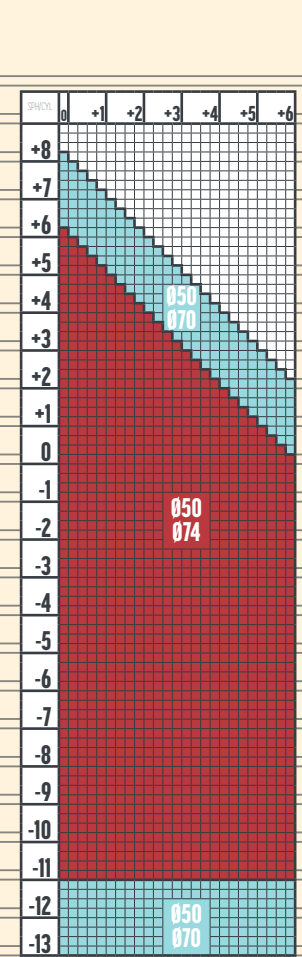

CULORI TRANSITIONS XTRACTIVE



1.67 ORGANIC INDIVIDUAL
1.67 ORGANIC PLUS
1.67 ORGANIC*
TRANSITIONS

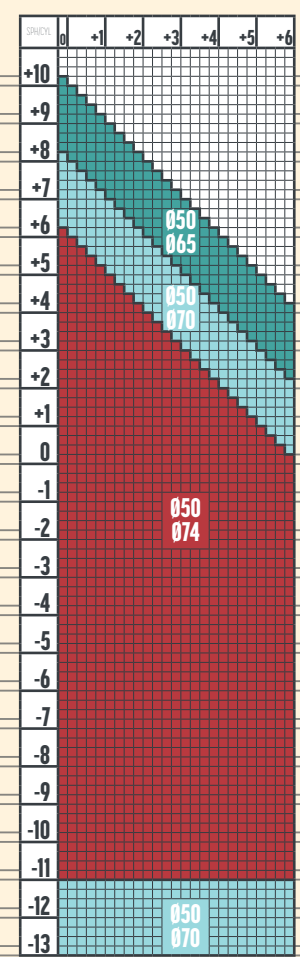

CULORI TRANSITIONS



1.6 ORGANIC INDIVIDUAL
1.6 ORGANIC PLUS
1.6 ORGANIC*
TRANSITIONS / TRANSITIONS XTRACTIVE

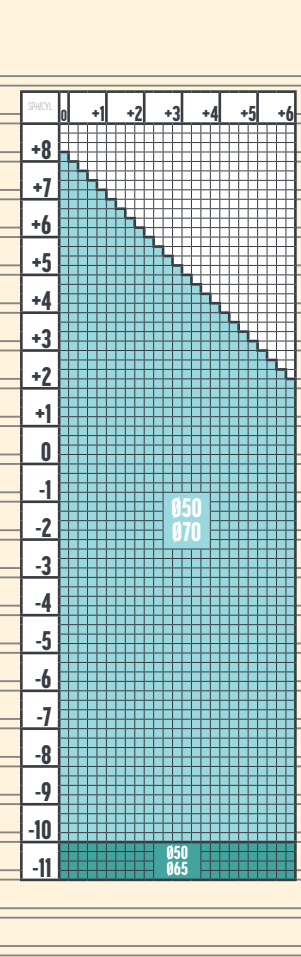

CULORI TRANSITIONS XTRACTIVE



CULORI TRANSITIONS



1.59 POLY INDIVIDUAL
1.59 POLY PLUS
1.59 POLY*
TRANSITIONS / TRANSITIONS XTRACTIVE

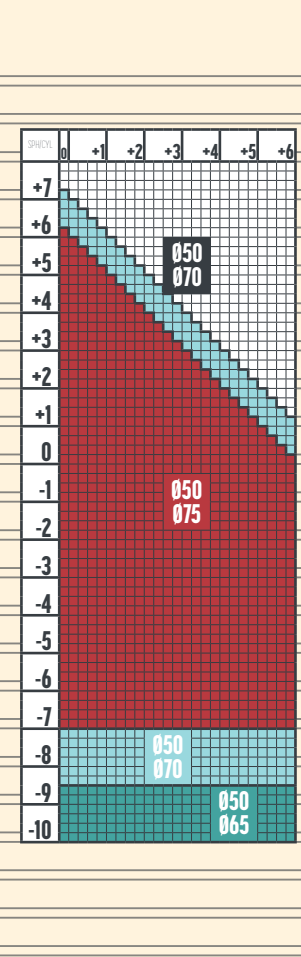

CULORI TRANSITIONS XTRACTIVE



CULORI TRANSITIONS



1.56 ORGANIC INDIVIDUAL
1.56 ORGANIC PLUS
1.56 ORGANIC*
PHOTO

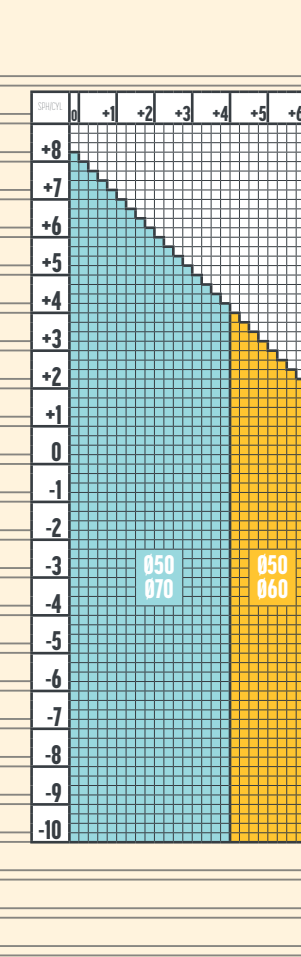

CULORI PHOTO



1.53 TRIVEX INDIVIDUAL
1.53 TRIVEX PLUS
1.53 TRIVEX*
TRANSITIONS / TRANSITIONS XTRACTIVE

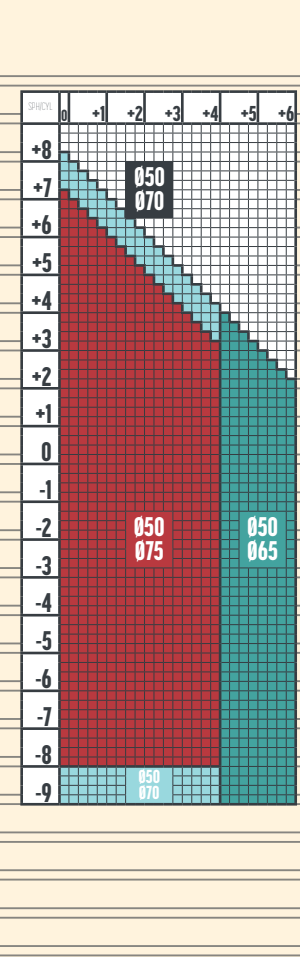

CULORI TRANSITIONS XTRACTIVE



CULORI TRANSITIONS



1.5 ORGANIC INDIVIDUAL
1.5 ORGANIC PLUS
1.5 ORGANIC*
TRANSITIONS / TRANSITIONS XTRACTIVE

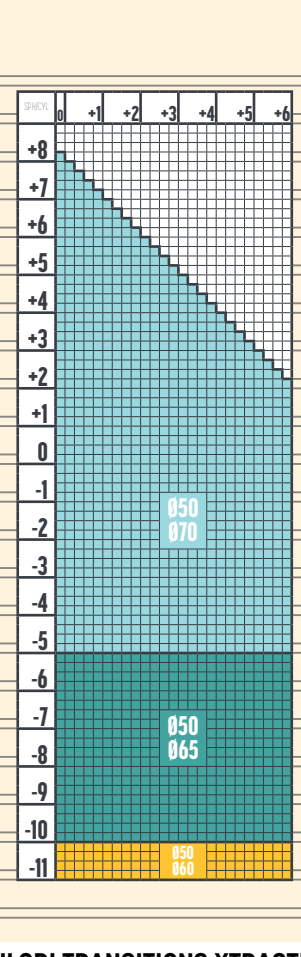

CULORI TRANSITIONS XTRACTIVE



CULORI TRANSITIONS

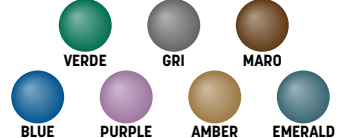

Colorare	NU	NU	NU	NU	NU	NU	NU	NU
Tratamente disponibile	ARUS BLUE / ARUS / ULTRA BLUE / ULTRA / HYDRO+ / HMC	ARUS BLUE / ARUS / ULTRA BLUE / ULTRA / HYDRO+ / HMC	ARUS BLUE / ARUS / ULTRA BLUE / ULTRA / HYDRO+ / HMC	ARUS BLUE / ARUS / ULTRA BLUE / ULTRA / HYDRO+ / HMC / HC	ARUS BLUE / ARUS / ULTRA BLUE / ULTRA / HYDRO+ / HMC / HC	ARUS BLUE / ARUS / ULTRA BLUE / ULTRA / HYDRO+ / HMC / HC	ARUS BLUE / ARUS / ULTRA BLUE / ULTRA / HYDRO+ / HMC / HC	ARUS BLUE / ARUS / ULTRA BLUE / ULTRA / HYDRO+ / HMC / HC
Tratamente aditionale	-	-	-	PURE	-	-	-	PURE

MONOFOCAL ORGANIC INDIVIDUAL, ORGANIC PLUS, ORGANIC
LENTILE FOTOCROMATICE
INDICE: 1.74 / 1.67 / 1.6 / 1.59 / 1.56 / 1.53 / 1.5

***Tratamentele ARUS BLUE și ARUS sunt disponibile doar pentru produsele ORGANIC INDIVIDUAL și ORGANIC PLUS.**

MONOFOCAL ORGANIC INDIVIDUAL, ORGANIC PLUS, ORGANIC - LENTILE POLARIZANTE - INDICE 1.67 AS / 1.67 / 1.6 / 1.59 / 1.53 / 1.5

1.67 ORGANIC INDIVIDUAL NUPOLAR
1.67 ORGANIC PLUS NUPOLAR
1.67 ORGANIC NUPOLAR*
1.67 AS ORGANIC NUPOLAR*

1.6 ORGANIC INDIVIDUAL NUPOLAR
1.6 ORGANIC PLUS NUPOLAR
1.6 ORGANIC NUPOLAR*

1.59 POLY INDIVIDUAL NUPOLAR
1.59 POLY PLUS NUPOLAR
1.59 POLY NUPOLAR*

1.59 POLY INDIVIDUAL
1.59 POLY PLUS
1.59 POLY*
TRANSITIONS DRIVEWEAR

1.53 TRIVEX NUPOLAR

1.53 TRIVEX INDIVIDUAL NUPOLAR
1.53 TRIVEX PLUS NUPOLAR

1.5 ORGANIC INDIVIDUAL NUPOLAR
1.5 ORGANIC PLUS NUPOLAR
1.5 ORGANIC NUPOLAR*

1.5 ORGANIC INDIVIDUAL
1.5 ORGANIC PLUS
1.5 ORGANIC*
TRANSITIONS DRIVEWEAR

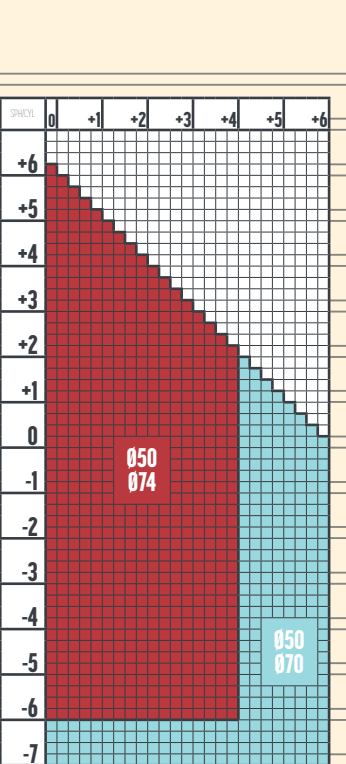
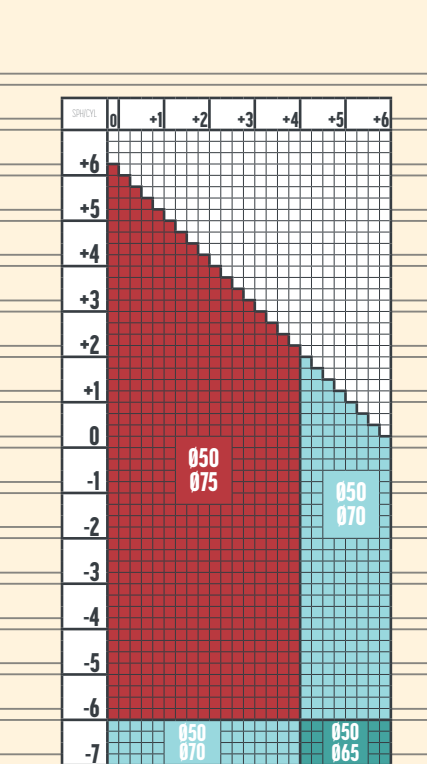
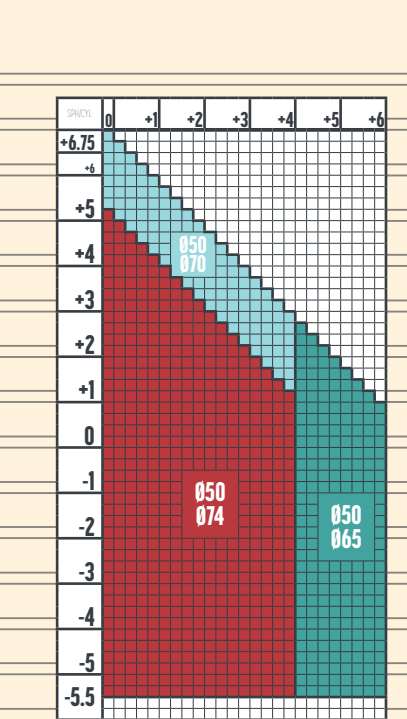
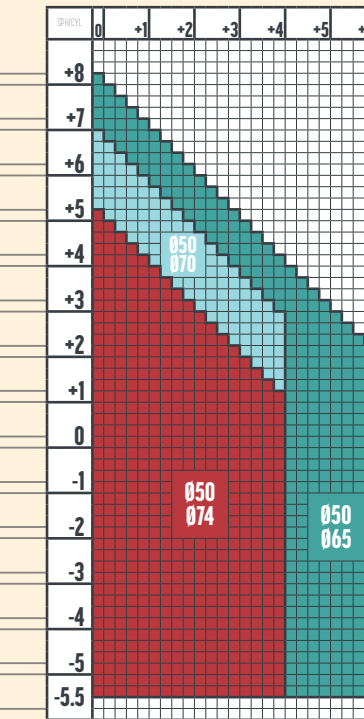
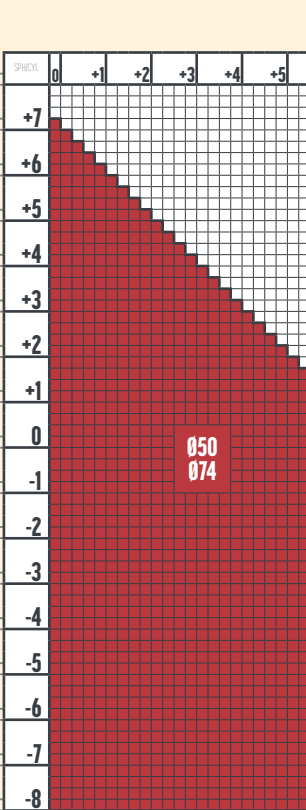
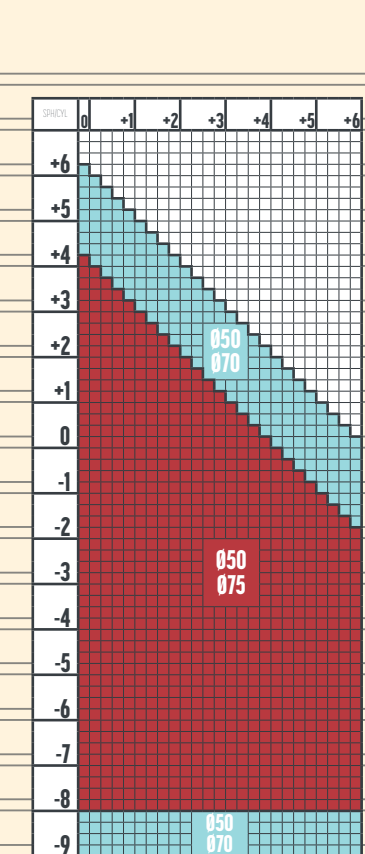
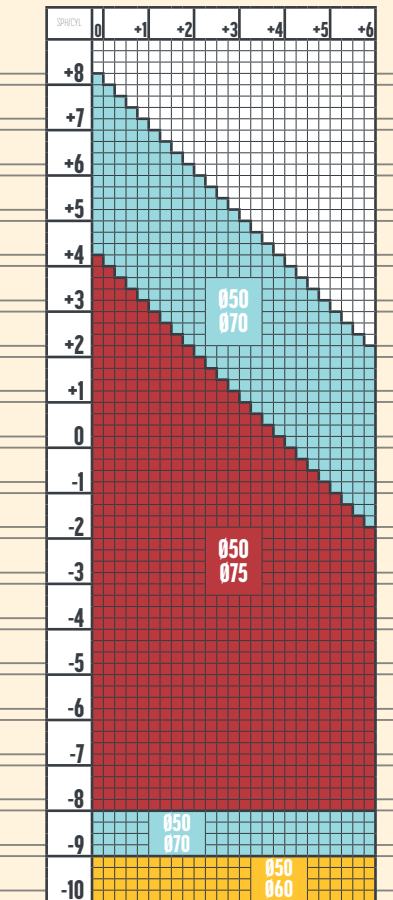
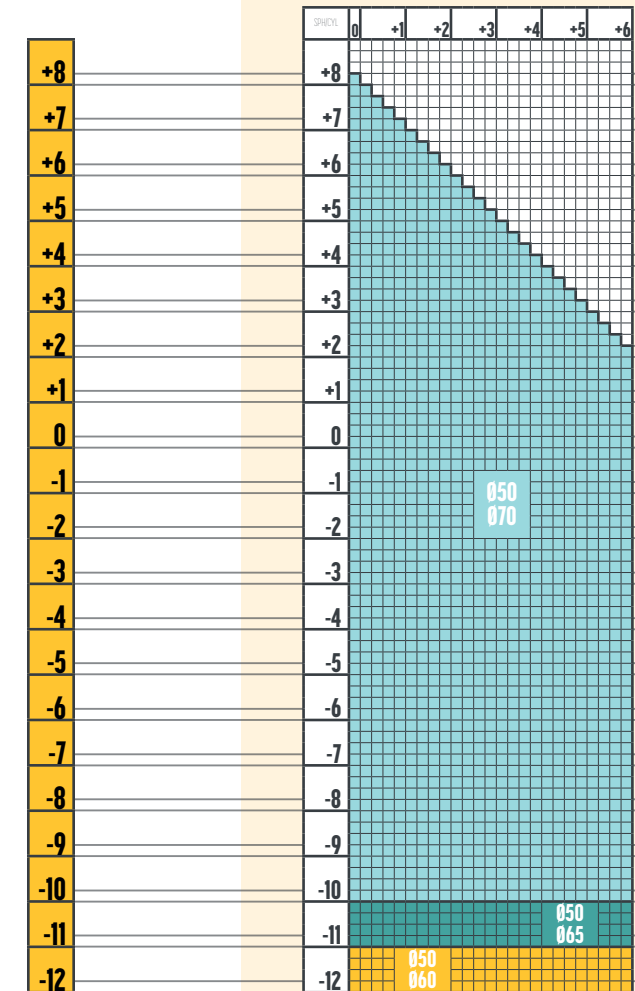

CULORI NUPOLAR
VERDE G15 GRI3 MARO

CULORI NUPOLAR
VERDE G15 GRI3 MARO

CULORI NUPOLAR
VERDE G15 GRI3 INFINITE GREY MARO

CULORI NUPOLAR
GRI3 MARO

CULORI NUPOLAR
GRI3 MARO

CULORI NUPOLAR
VERDE G15 MARO
GRI1 GRI3 INFINITE GREY

Colorare	NU	NU	NU	NU	NU	NU	NU	NU
Tratamente disponibile	ARUS / ULTRA / HYDRO+ / HMC	ARUS / ULTRA / HYDRO+ / HMC	ARUS / ULTRA / HYDRO+ / HMC / HC	ARUS / ULTRA / HYDRO+ / HMC / HC	ULTRA / HYDRO+ / HMC / HC	ARUS / ULTRA / HYDRO+ / HMC / HC	ARUS / ULTRA / HYDRO+ / HMC / HC	ARUS / ULTRA / HYDRO+ / HMC / HC
Tratamente aditionale	-	PURE	-	-	-	-	PURE	PURE

**MONOFOCAL ORGANIC INDIVIDUAL, ORGANIC PLUS, ORGANIC
LENTILE POLARIZANTE
INDICE: 1.67 AS / 1.67 / 1.6 / 1.59 / 1.53 / 1.5**

***Tratamentul ARUS este disponibil doar pentru produsele ORGANIC INDIVIDUAL
și ORGANIC PLUS.**

MONOFOCAL MINERAL - LENTILE TRANSPARENTE - INDICE: 1.9/1.8/1.7/1.6/1.5

1.9 MINERAL

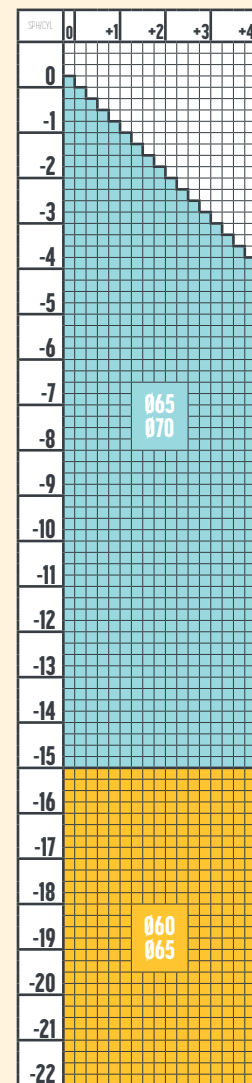

1.8 MINERAL

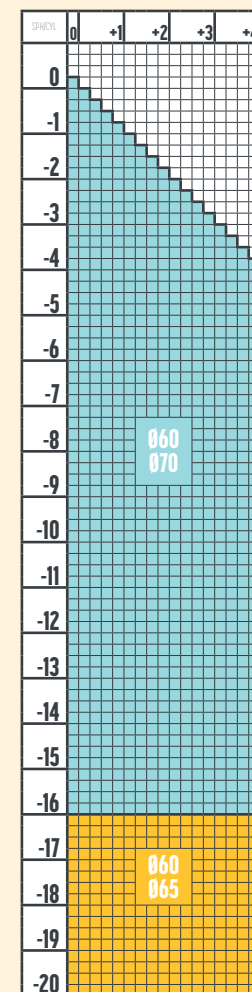

1.7 MINERAL

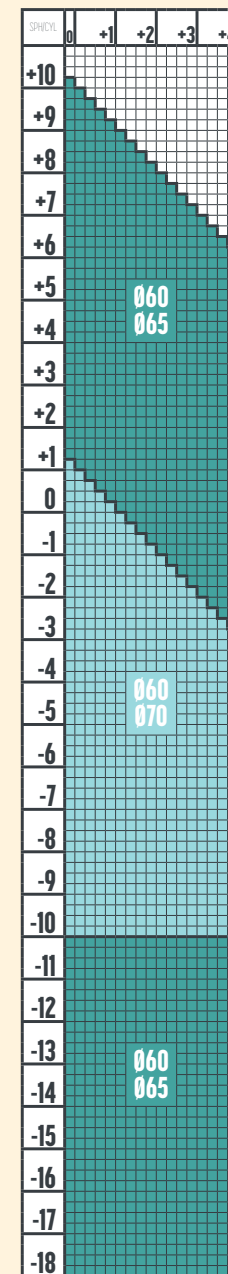

1.6 MINERAL

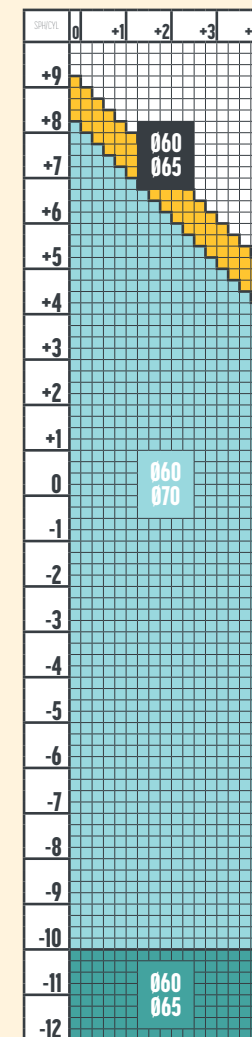

1.5 MINERAL

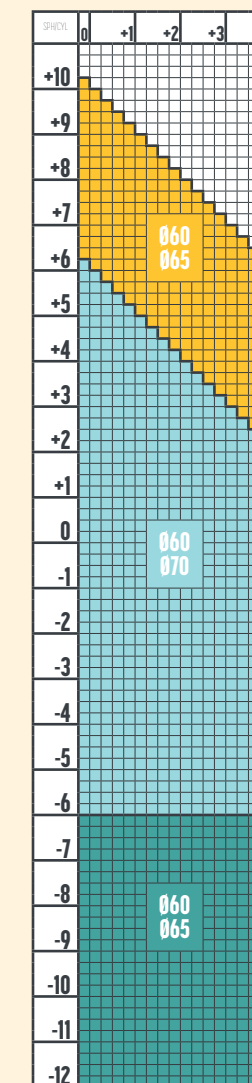

Colorare	DA
Tratamente disponibile	AR
Tratamente adiționale	-

Colorare disponibilă	
Culoare	Procentaj colorare
GRI SOLID	25%
GRI SOLID	50%
GRI SOLID	75%
MARO SOLID / GRADIENT	15%
MARO SOLID / GRADIENT	25%
MARO SOLID / GRADIENT	50%
MARO SOLID / GRADIENT	75%

MONOFOCAL MINERAL

LENTILE TRANSPARENTE

INDICE: 1.9 / 1.8 / 1.7 / 1.6 / 1.5

MONOFOCAL MINERAL - LENTILE FOTOCROMATICE - INDICE: 1.6 / 1.5

1.6 MINERAL - PHOTO

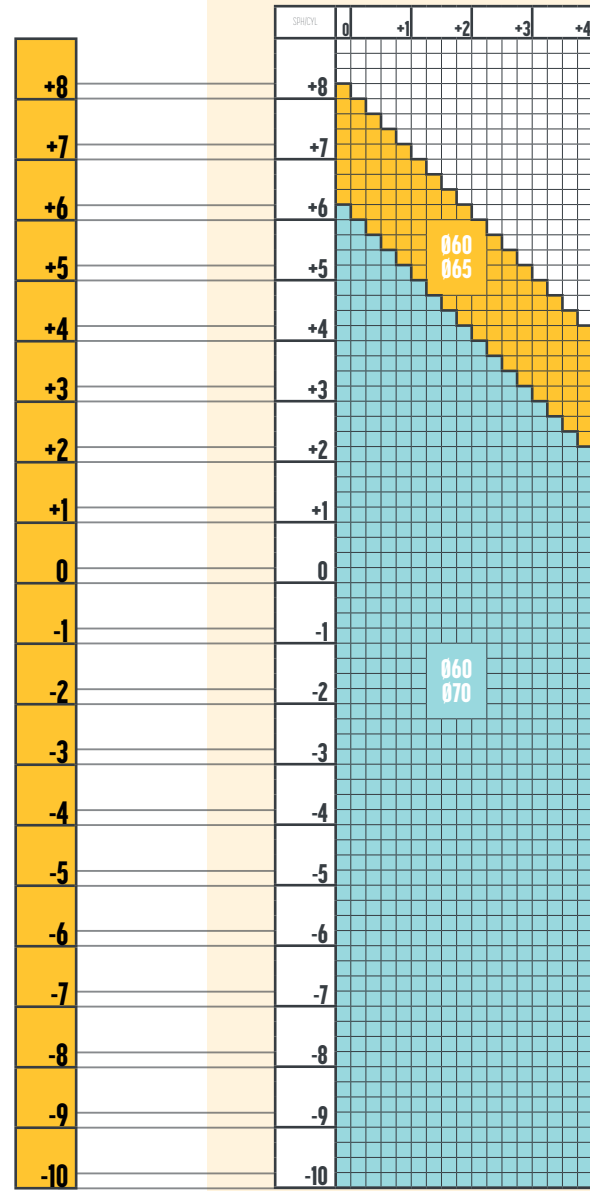

CULORI PHOTO



MARO

1.5 MINERAL - PHOTO

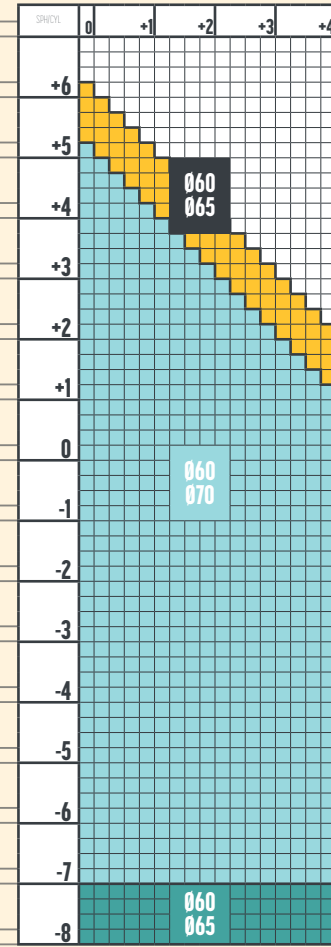

CULORI PHOTO



GRI



MARO

Colorare	NU	NU
Tratamente disponibile	ULTRA / HYDRO+ / AR (disponibil și UC)	ULTRA / HYDRO+ / AR (disponibil și UC)
Tratamente adiționale	-	-

MONOFOCAL MINERAL
LENTILE FOTOCROMATICE
INDICE: 1.6 / 1.5

ȘABLOANE

ORGANIC PROGRESIV

CAMBER FREESTYLE

- XS - înălțime minimă / recomandată montaj: 14/16 mm;
- XS/S - înălțime minimă / recomandată montaj: 15/17 mm;
- S - înălțime minimă / recomandată montaj: 16/18 mm;
- S/M - înălțime minimă / recomandată montaj: 17/19 mm;
- M - înălțime minimă / recomandată montaj: 18/20 mm;
- M/L - înălțime minimă / recomandată montaj: 19/21 mm;
- L - înălțime minimă / recomandată montaj: 20/22 mm.

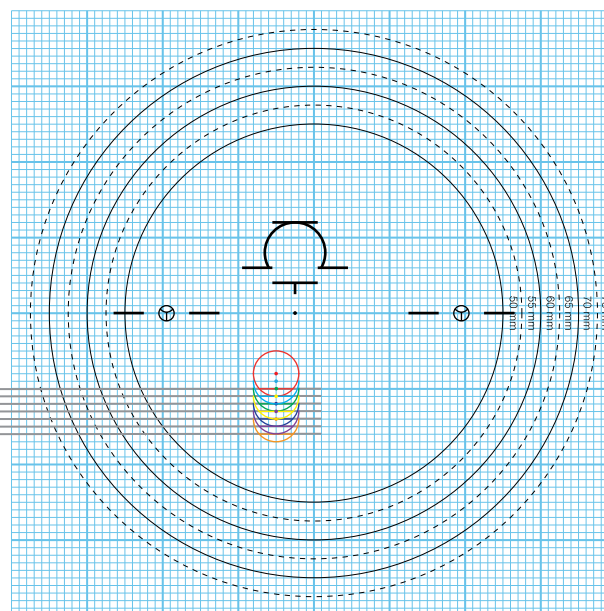
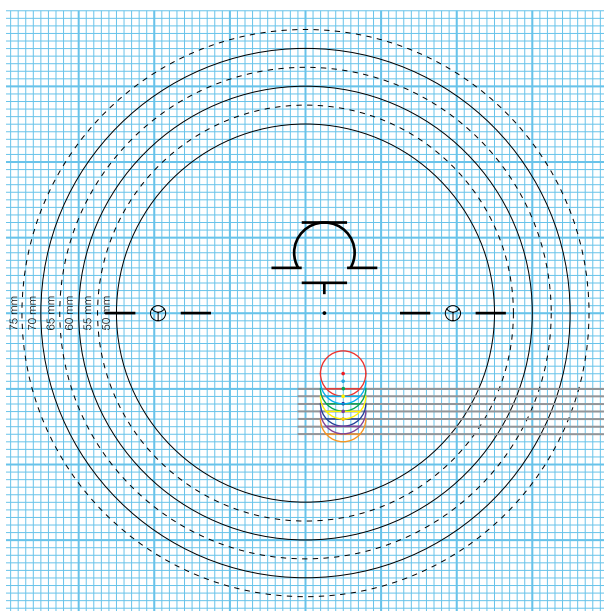
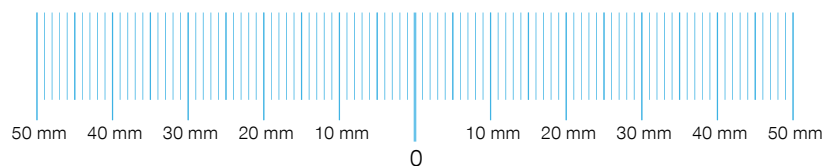

XS/S
S/M
M/L

XS
S
M
L

ORGANIC PROGRESIV

**CAMBER STEADY
INDIVIDUAL, PLUS**

XS - înălțime minimă / recomandată montaj: 14/16 mm;

S - înălțime minimă / recomandată montaj: 16/18 mm;

M - înălțime minimă / recomandată montaj: 18/20 mm;

L - înălțime minimă / recomandată montaj: 20/22 mm.

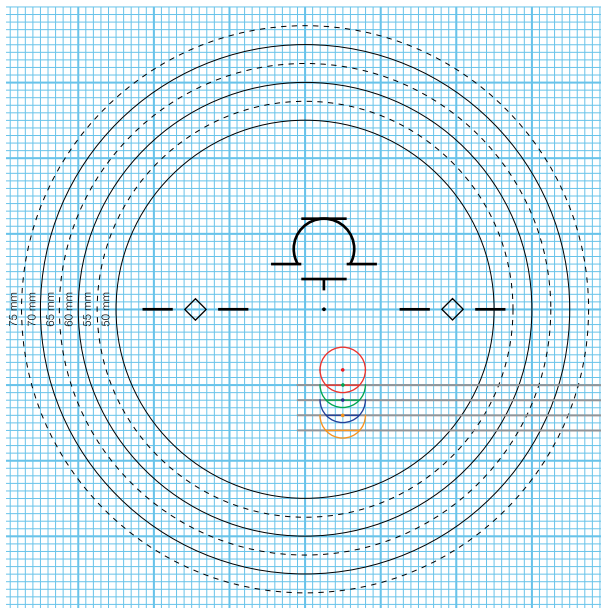
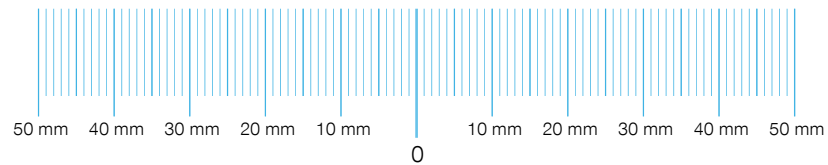

XS
S
M
L

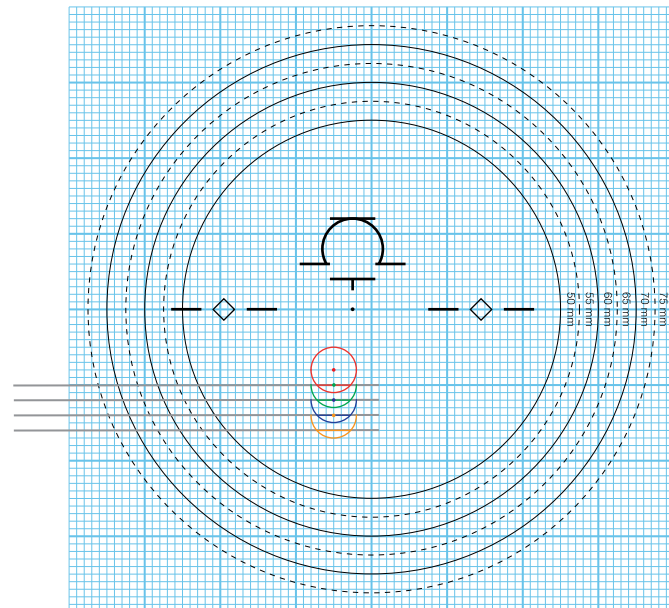

ORGANIC PROGRESIV
INNOVATOR
INDIVIDUAL, PLUS, SIMPLU

XS - înălțime minimă / recomandată montaj: 14/16 mm;
 S - înălțime minimă / recomandată montaj: 16/18 mm;
 M - înălțime minimă / recomandată montaj: 18/20 mm;
 L - înălțime minimă / recomandată montaj: 20/22 mm.

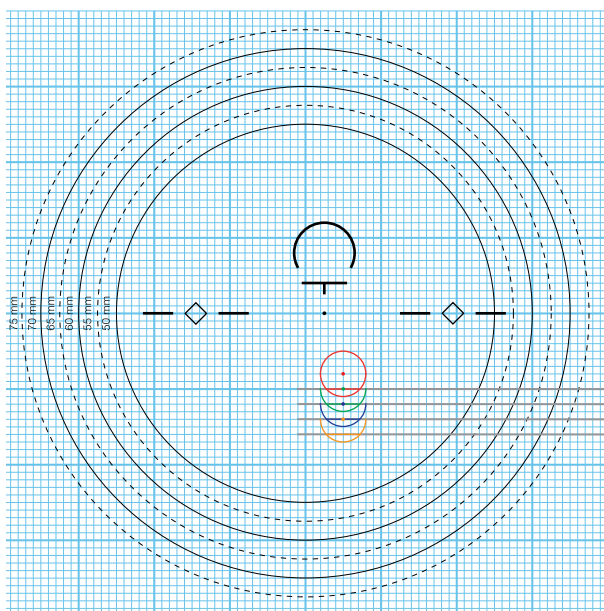
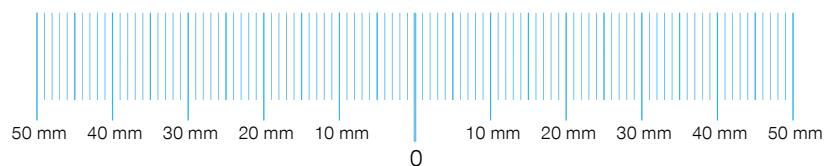

XS
S
M
L

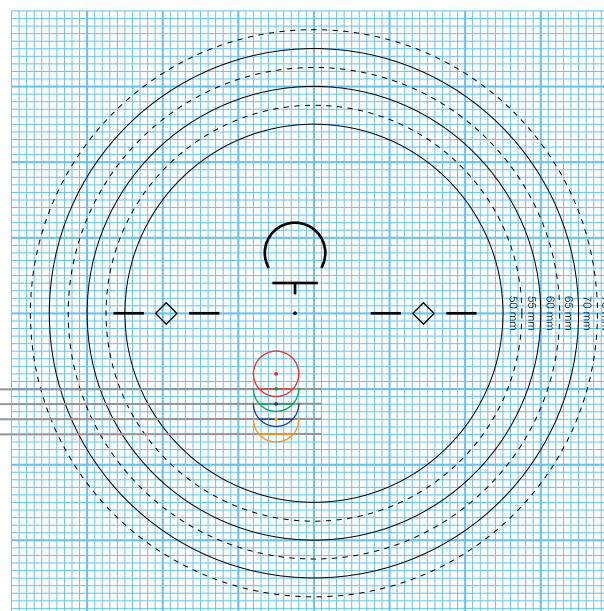

MINERAL PROGRESIV INNOVATOR

M - înălțime minimă / recomandată montaj: 18/21 mm.

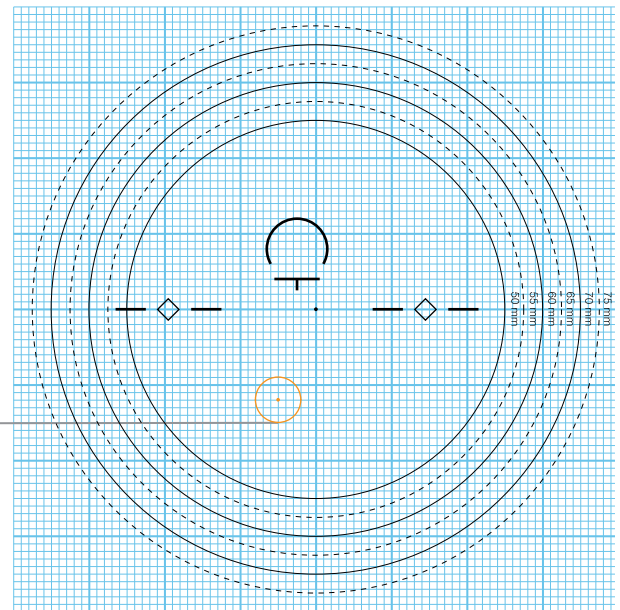
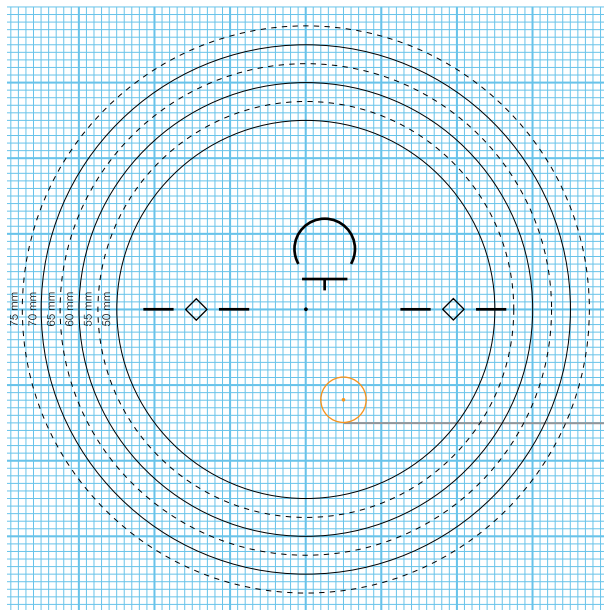
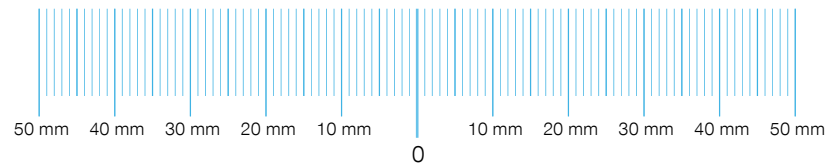

L

ORGANIC PROGRESIV
FACILE

XS - Înălțime minimă / recomandată montaj: 14/16 mm.

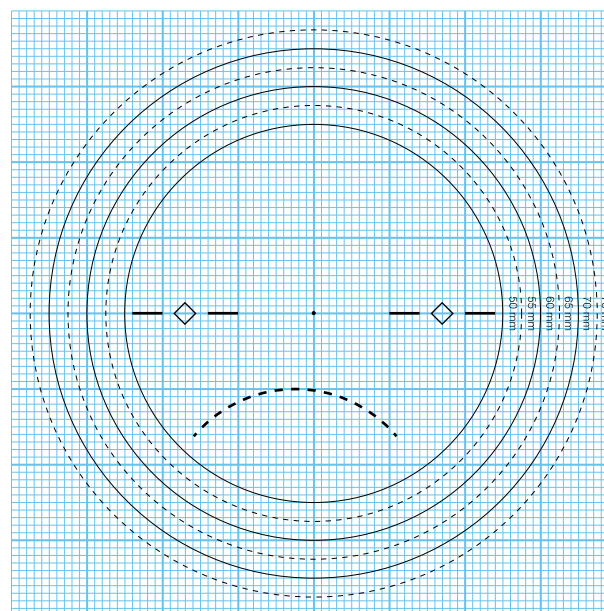
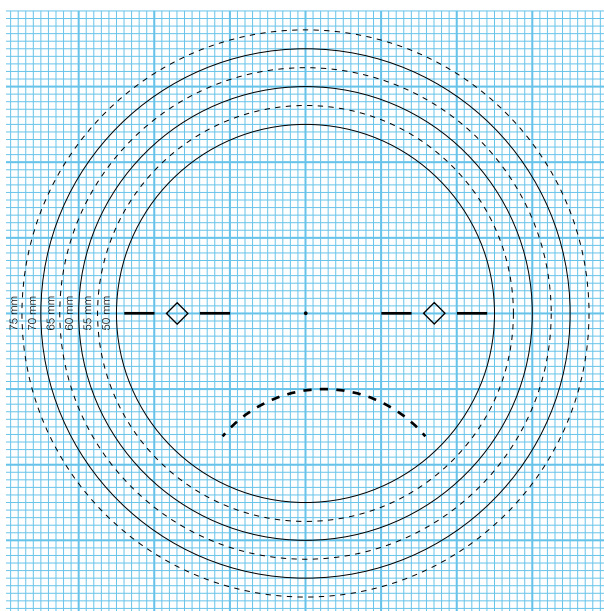
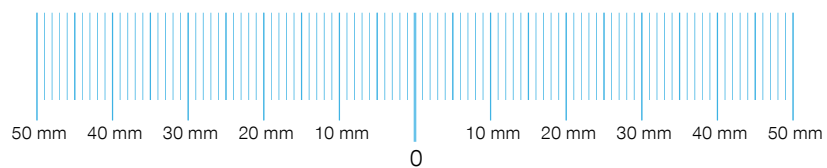

ORGANIC DEGRESIV

INNOVATOR
HOME, OFFICE, DESKTOP, COMPUTER

M - Înălțime minimă / recomandată montaj: 18/20 mm.

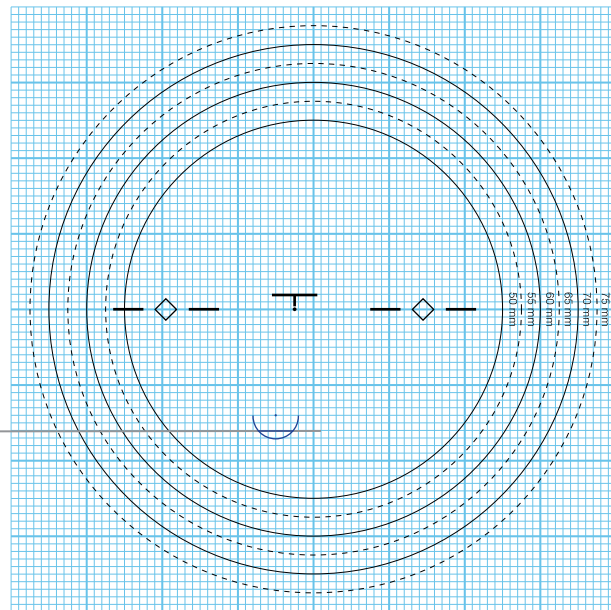
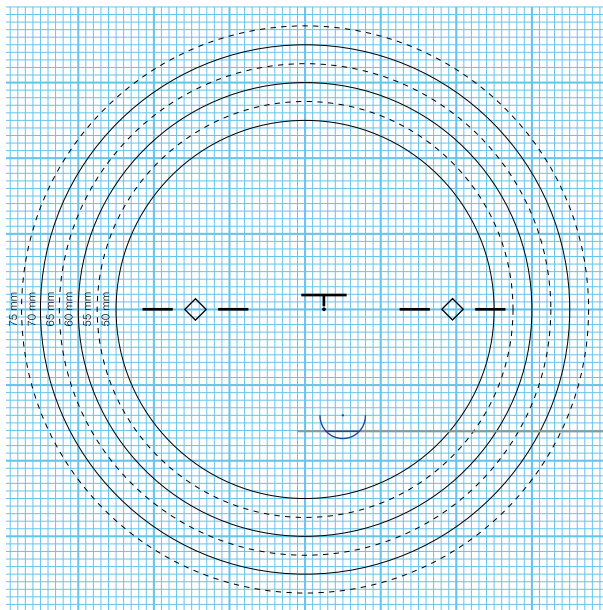
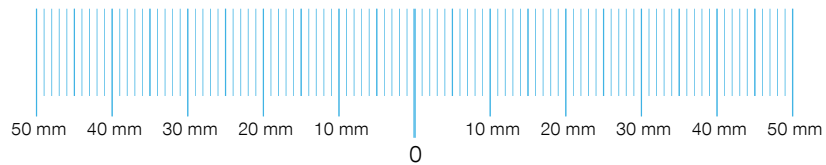

ORGANIC BIFOCAL RS24

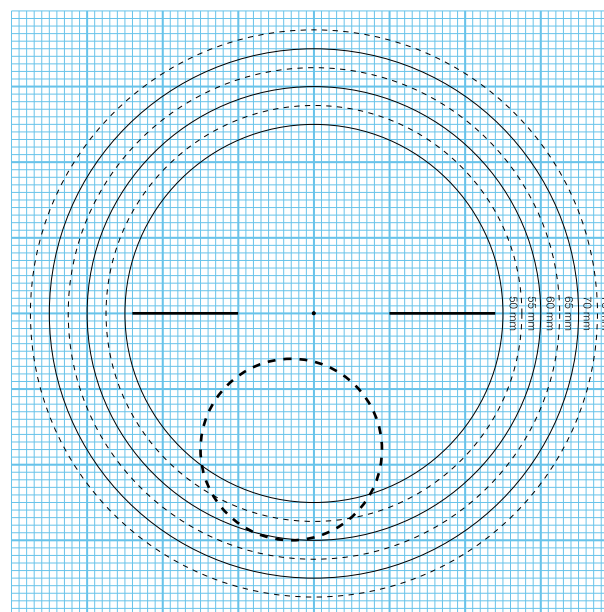
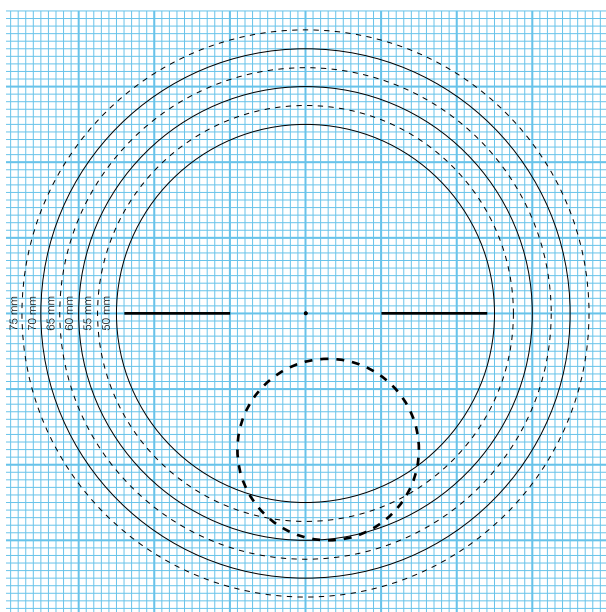
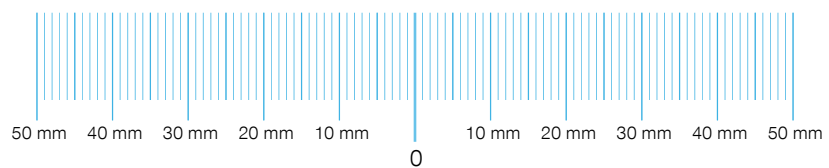

ORGANIC BIFOCAL

CT28, FT28 - INDICE 1.67AS

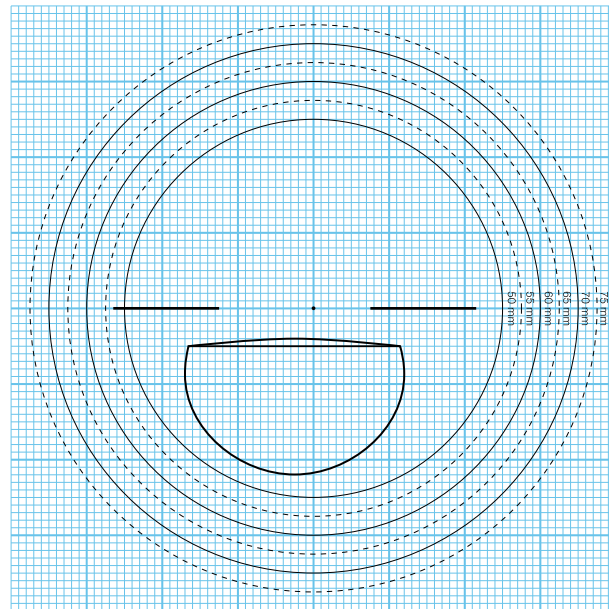
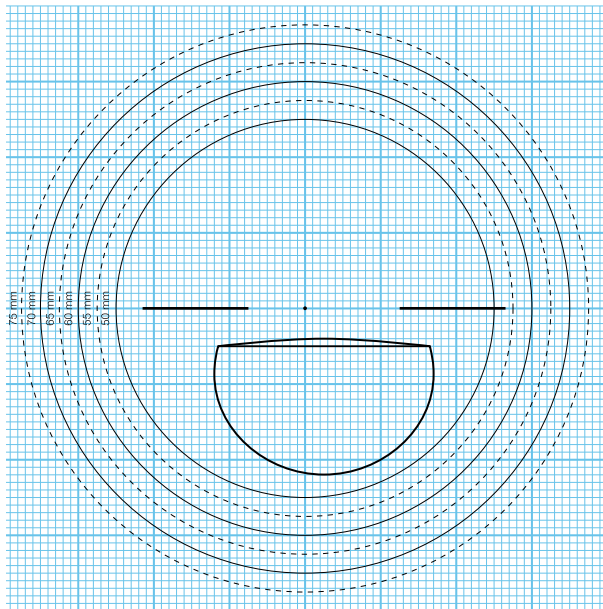
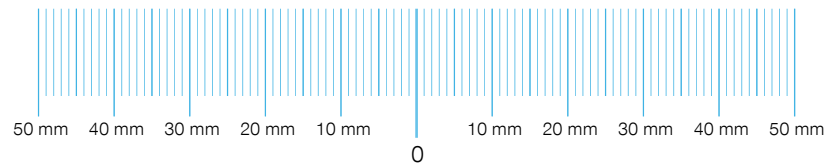

ORGANIC BIFOCAL
CT28

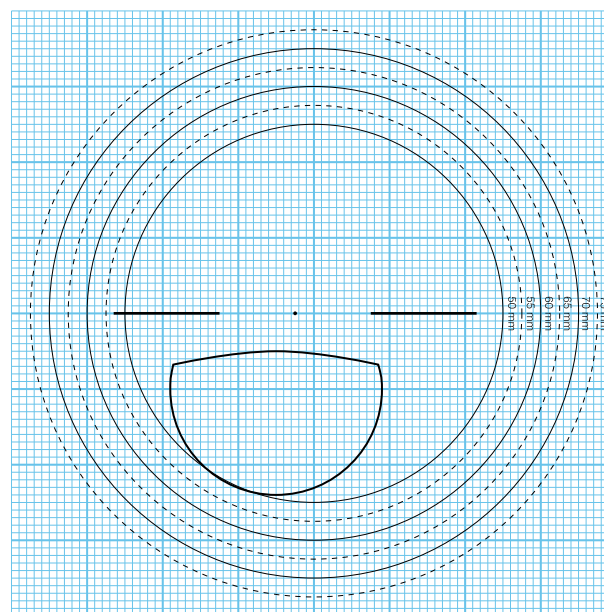
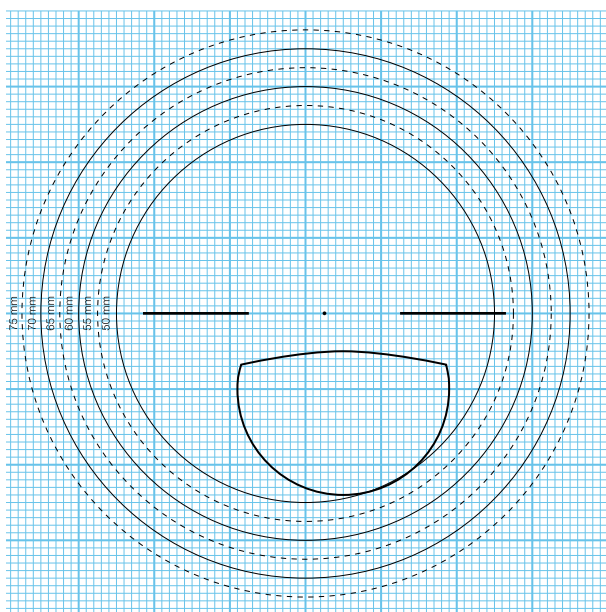
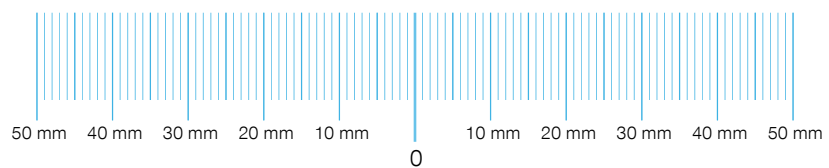

ORGANIC BIFOCAL FT45

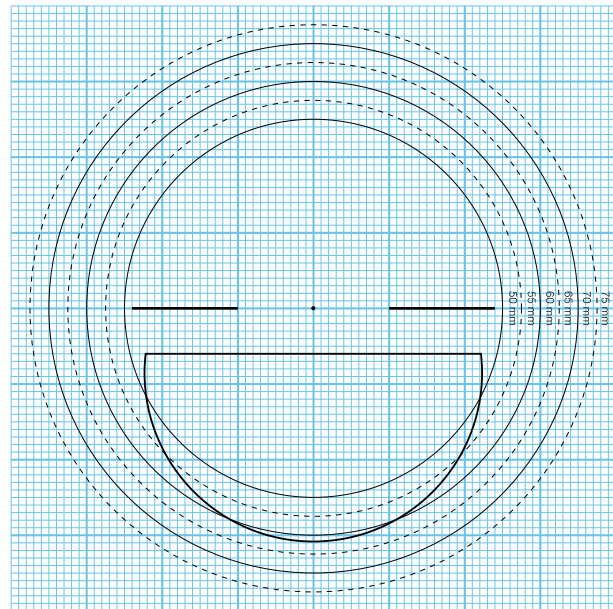
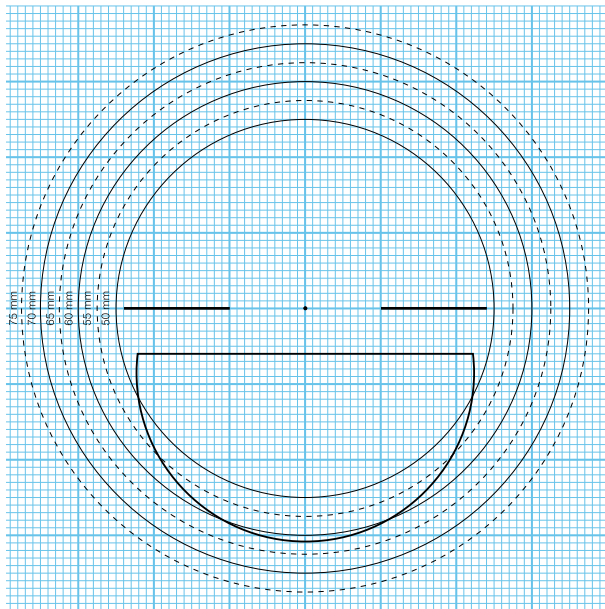
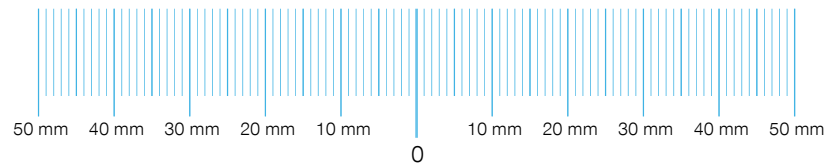

ORGANIC BIFOCAL

FT28, FT35

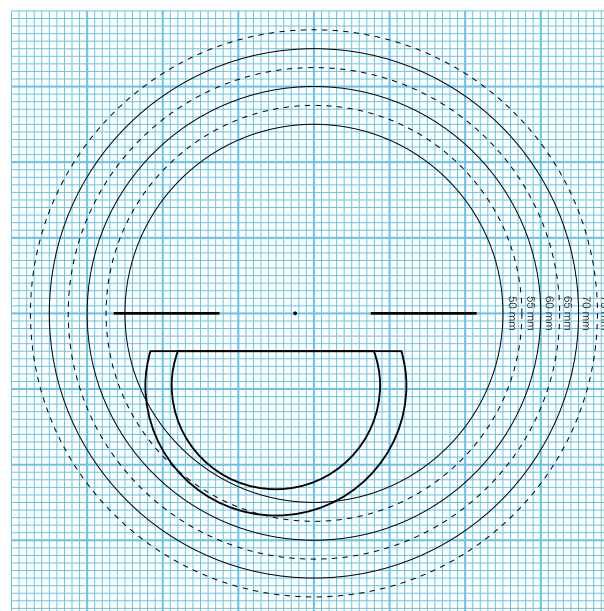
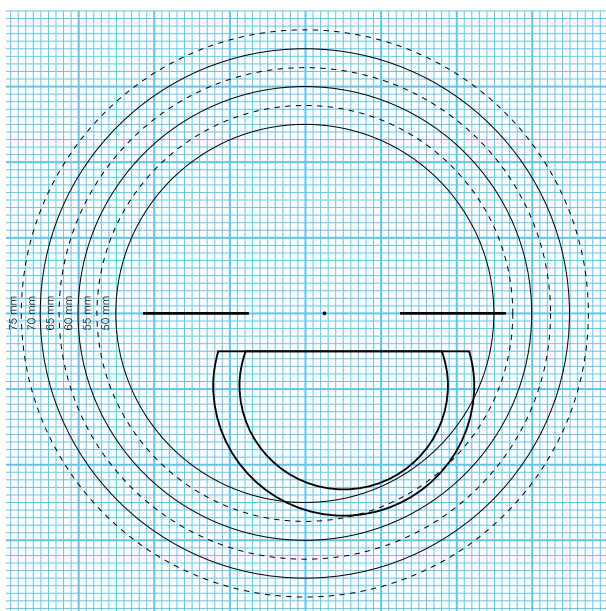
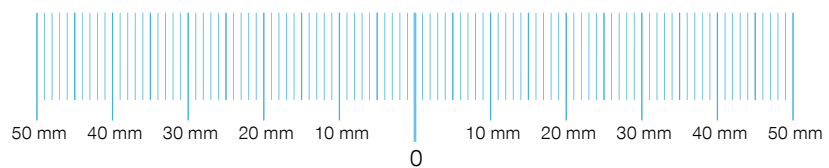

MINERAL BIFOCAL

FT28

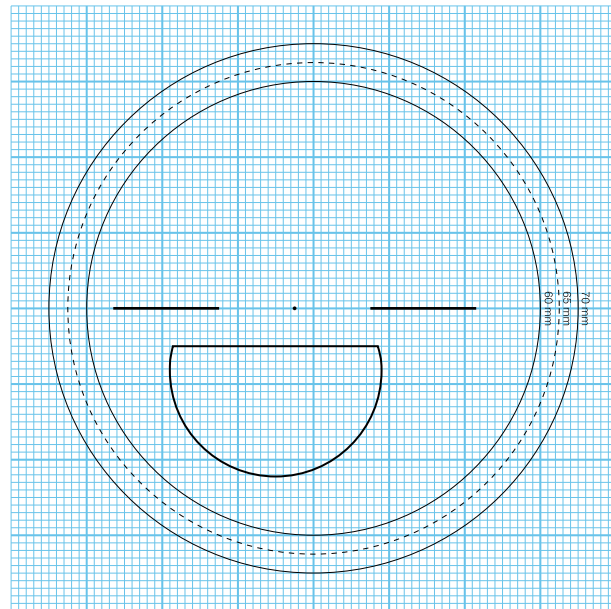
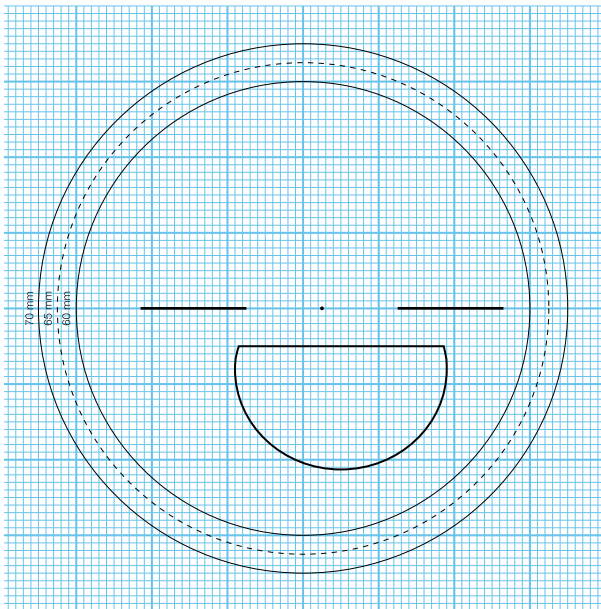
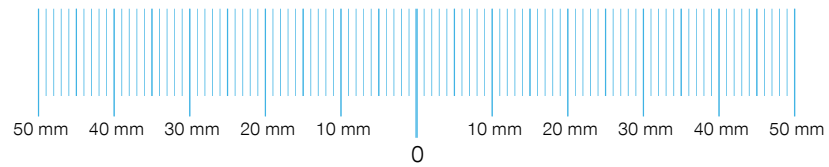

ORGANIC BIFOCAL DIGITAL RS28 / RS40

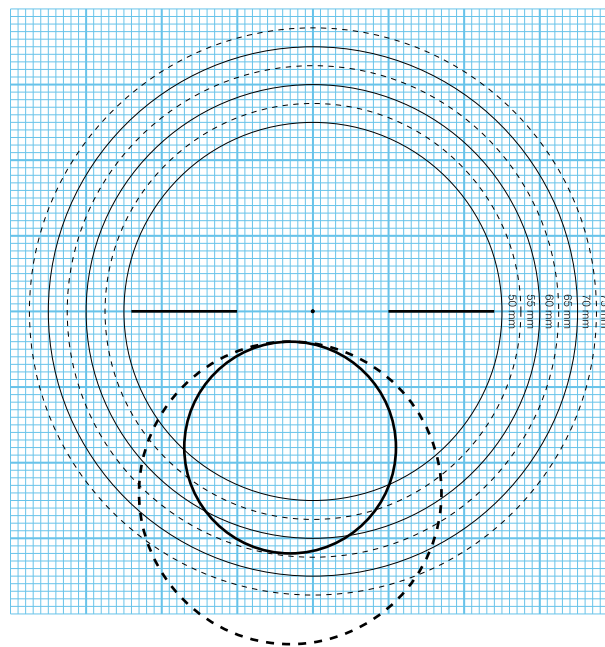
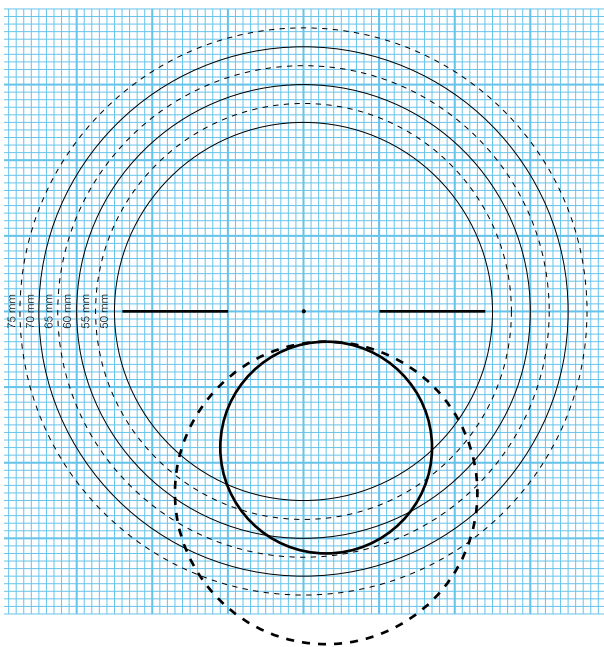
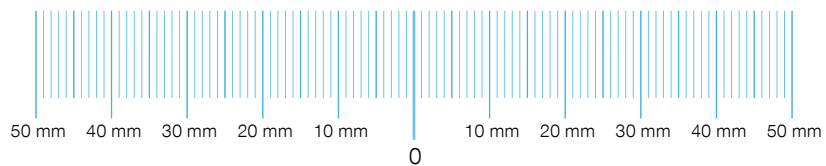

ORGANIC BIFOCAL E-LINE

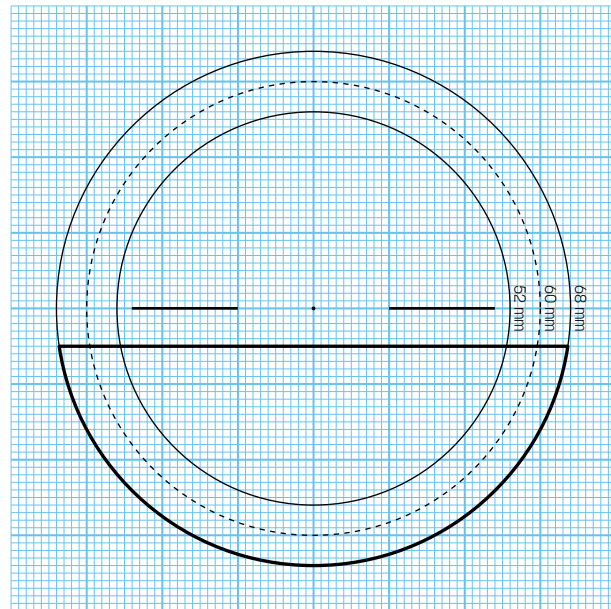
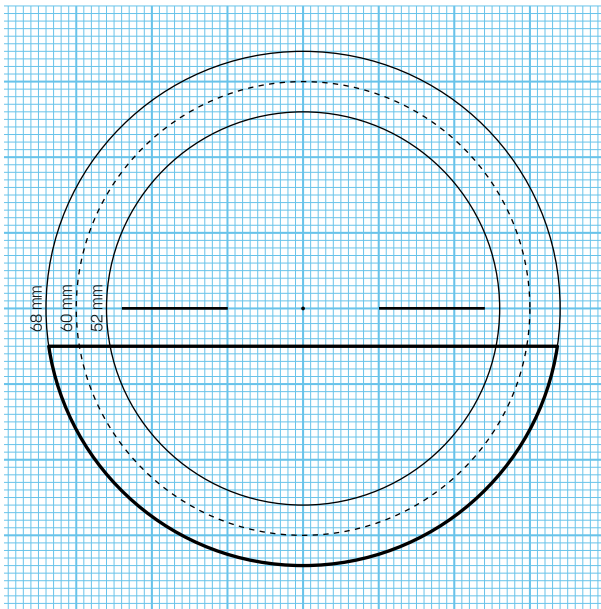
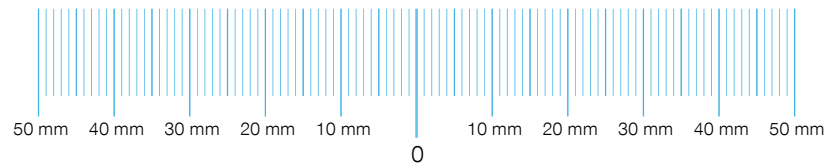

ORGANIC MONOFOCAL
INDIVIDUAL, PLUS
NUPOLAR / DRIVEWEAR

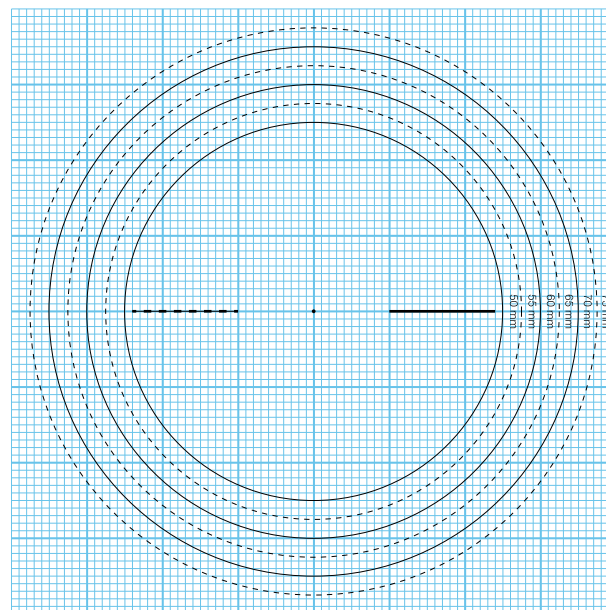
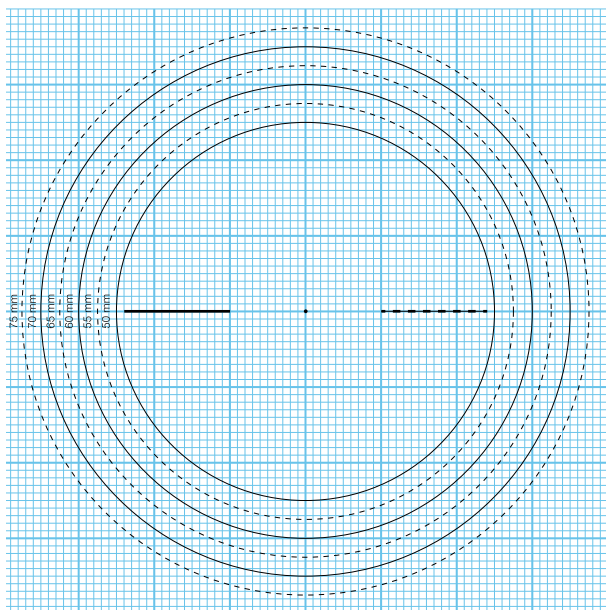
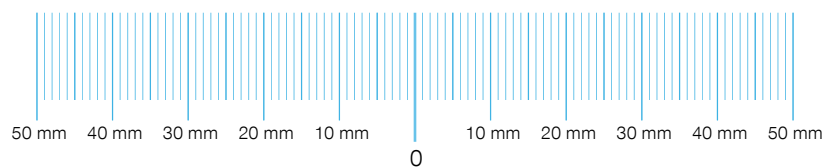

INFORMAȚII GRAVURI

	TEMPORAL SUS	TEMPORAL JOS	NAZAL SUS	NAZAL JOS	SIMBOL
CAMBER FREESTYLE	RV	ADD	CFXA	CORIDOR	⊕ ⊗
CAMBER STEADY INDIVIDUAL	RV	ADD	CIA	CORIDOR	◇ ◇
CAMBER STEADY PLUS	RV	ADD	CPA	CORIDOR	◇ ◇
INNOVATOR INDIVIDUAL	RV	ADD	IIA	CORIDOR	◇ ◇
INNOVATOR PLUS	RV	ADD	IPA	CORIDOR	◇ ◇
INNOVATOR	RV	ADD	IA	CORIDOR	◇ ◇
INNOVATOR COMPUTER	RV	ADD	ICA	13	◇ ◇
INNOVATOR DESKTOP	RV	ADD	IDA	20	◇ ◇
INNOVATOR OFFICE	RV	ADD	IOA	40	◇ ◇
INNOVATOR HOME	RV	ADD	IHA	60	◇ ◇
FACILE	RV	ADD	FA		◇ ◇
BIFOCAL DIGITAL	RV	ADD	BDA		◇ ◇
ORGANIC INDIVIDUAL	RV		OIA		◇ ◇
ORGANIC PLUS	RV		OPA		◇ ◇

	CODIFICARE INDICE (A)
1.5	1
1.53	T
1.56	5
1.59	P
1.6	2
1.67	3
1.74	4

CAMBER FREESTYLE

SOLUȚIA

Vedere la aproape
 Vedere la distanță
 Prim purtător
 Design echilibrat

X

N

D

F

B

EXEMPLU:

Innovator 1.5
 Coridor: L
 Adiție: 1.25

